

Delta Mobrey Ltd

SIL SAFETY MANUAL

PRESSURE AND DIFFERENTIAL PRESSURE TRANSMITTER

D21 Safety
D31 Safety

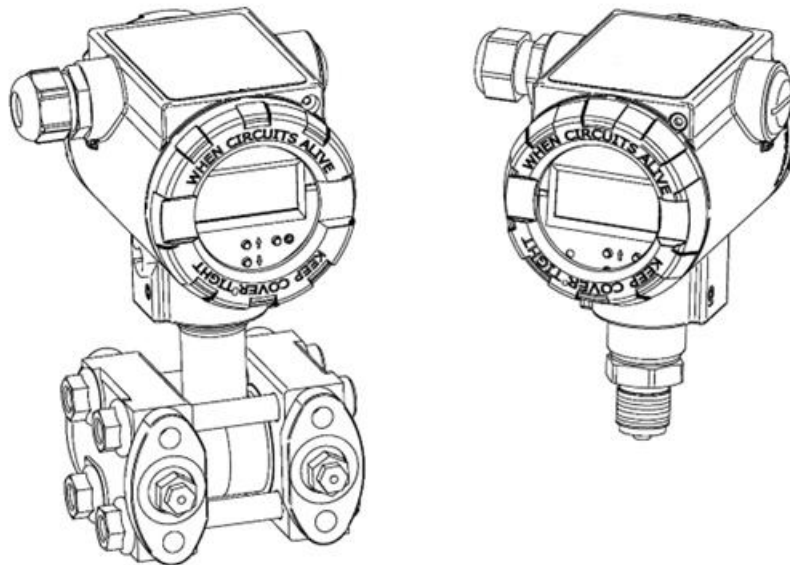

Delta Mobrey Ltd
Hudson House, Albany Park Camberley Surrey, GU16 7PL, UK.
+44(0) 1252 729 140, fax +44(0)1252 729 168
www.delta-mobrey.com, e-mail: salesadmin@delta-mobrey.com

PRODUCT CODE – see: section 5.2. of the User’s Manual.

The QR code or ID number identifies the transmitter and provides quick access to the following documentation on the manufacturer’s website: user’s manual, SIL safety manual, explosion-proof device user manual, technical information, declarations of conformity and copies of certificates.

TDS D21- D21 Safety

D21 Safety ID: 0022 0004 0002

<https://www.delta-mobrey.com/wp-content/uploads/2017/01/TDS-D21-H.pdf>

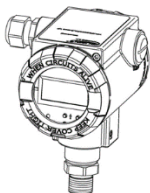

TDS D31 – D31 Safety

D31 Safety ID•. 0023 0004 0002

<https://www.delta-mobrey.com/wp-content/uploads/2023/07/TDS-D31-J.pdf>

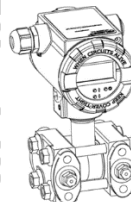

IOM D21/D31-

ID: 0022 0004 0002 / ID•. 0023 0004 0002

<https://www.delta-mobrey.com/wp-content/uploads/2017/01/TDS-D21-H.pdf>

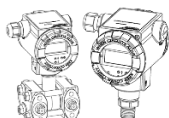

IOM D21/D31 Exd

ID: 0022 0004 0002 / ID•. 0023 0004 0002

<https://www.delta-mobrey.com/wp-content/uploads/2017/01/IOM-D21-D31-EX-D-CAM.pdf>

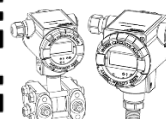

IOM D21/D31- Exi

I D21 Safety ID: 0022 0004 0002

<https://www.delta-mobrey.com/wp-content/uploads/2017/01/IOM-D21-D31-EX-IS-A-NOV-2019-revised-july-2021-CAM.pdf>

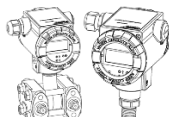

Symbols used

Symbol	Description
	Warning to proceed strictly in accordance with the information contained in the documentation in order to ensure the safety and full functionality of the device.

BASIC FUNCTIONAL SAFETY REQUIREMENTS

The manufacturer will not be liable for damage resulting from incorrect installation, failure to maintain suitable technical condition of the device or use of the device other than for its intended purpose.

Installation should be carried out by qualified staff having the required authorizations to install electrical and I&C equipment. The installer is responsible for performing the installation in accordance with manual as well as with the electromagnetic compatibility and safety regulations and standards applicable to the type of installation.

The E/E/PE safety-related system should be configured in accordance with the application. Improper configuration may cause malfunction leading to a E/E/PE safety-related system failure or accident.

In systems with I&C equipment, in case of leakage, there is a danger to staff due to the medium under pressure. All safety and protection requirements must be observed during installation, operation and inspections of the E/E/PE safety-related system.

If the E/E/PE safety-related system is found to malfunction, disconnect it from the system and hand over to the manufacturer for repair.

In order to minimize the risk of malfunction and associated risks to staff, the E/E/PE safety-related system is not to be installed or used in particularly unfavourable conditions, where the following hazards occur:

- possible mechanical impacts, excessive shocks and vibration;
- excessive temperature fluctuation;
- water vapour condensation, dusting, icing.

For operation in functional safety loop D21 Safety transmitters shall be configured for the output signal of 4...20 mA. HART protocol or local buttons for changing the device settings can be used for diagnostics and transmitter configuration at a work station. After configuring and commissioning the functional safety system, use only the analogue current output signal.

For safety reasons, access to the transmitter enabling modification of the settings by unauthorized access must be prevented. The transmitters have the option of blocking local change of settings by software features and by sealing the housing cover.

Changes made to the manufacturing of products may be introduced before the paper version of the manual is updated. The up-to-date manuals are available on the manufacturer's website: www.deltamobrey.com.

Table of contents

1. SIL DECLARATION OF CONFORMITY	5
2. SIL CERTIFICATE	6
3. DEFINITIONS AND ACRONYMS	7
4. GENERAL INFORMATION	8
4.1. Technical parameters	8
5. DESCRIPTION OF SAFETY REQUIREMENTS AND RESTRICTIONS ..	8
5.1. Alarms.....	8
5.2. Restrictions	10
5.3. Notes on cybernetic security	10
6. SAFETY FUNCTION TESTS	11
6.1. Proof Test	11
6.2. Block diagram of the Verification Test (Proof Test)	15
7. REPAIR	17
8. RELIABILITY DATA	17
9. HISTORY OF REVISIONS.....	18
APPENDIX 1. CHECKLIST FOR VERIFICATION TEST (PROOF TEST) ...	19

1. SIL DECLARATION OF CONFORMITY



SIL Statement of Conformity

Document Number: 229 Rev A

Delta Mobrey Ltd.

Hudson House, Albany Park, Camberley, Surrey,
GU16 7PL, United Kingdom

We hereby declare, under our sole responsibility that:

pressure transmitters

D21 Safety ID:0001 0004 0002 XXXX XXXX XXXX XXXX XX¹⁾

differential pressure transmitters

D31 Safety ID: 0002 0004 0002 XXXX XXXX XXX XXXX XX¹⁾

¹⁾ X in the ID code is manufacturer's indication not related to the certificate

Meet the requirement of standards:

IEC 61508:2010 Part 1÷7

IEC 61511-1:2016+IEC 61511-1:2016/AMD1:2017

IEC 62061:2005 + IEC 62061:2005/AMD1:2012 + IEC 62061:2005/AMD2:2015

Products	λ_{total} FIT	λ_{NE} FIT	λ_{SD} FIT	λ_{SU} FIT	λ_{DD} FIT	λ_{du} FIT	SFF %	DC %	MTBF
D21 Safety	905,321	265.723	0	138,208	451,857	49,533	92,256	90,121	1,105x10 ⁶ h 126Yrs
D31 Safety	919,621	265,723	0	138.208	453,387	62,303	90,472	87,919	1,087x10 ⁶ h 124Yrs

HFT=0, Route 1H	SIL 2
HFT=1, Route 1H	SIL 3
Systematic Capability, Route 1s	SC 3 (SIL 3 Capable)
Subsystem	Type B

The products can be used in safety-related systems that meet the requirements up to and including SIL 3. SIL verification of a security-related system is the responsibility of the system integrator.

Certificate No. 1005/CW/001 was issued by UDT-CERT, Office of Technical Inspection, Szcęśliwicka 34 St., 02-353 Warsaw.

Authorised Signatory for the manufacturer:

Date: 4th October 2024

Dr. Kapila Mediliyegedara
Certification Manager

Your Trusted Partner in Process Instrumentation

Delta Mobrey Limited Hudson House, Albany Park, Camberley, Surrey, GU16 7PL
T +44 (0) 1252 729140 F +44 (0) 1252 729168 E sales@delta-mobrey.com W www.delta-mobrey.com

2. SIL CERTIFICATE



CERTIFICATE

No. 1005/CW/001 ver. 2

Office of Technical Inspection
Product Certification Body UDT-CERT

certifies that

pressure transmitters

D21 Safety ID: 0022 0004 0002 XXXX XXXX XXXX XXXX XX¹⁾

differential pressure transmitters

D31 Safety ID: 0023 0004 0002 XXXX XXXX XXXX XXXX XX¹⁾

¹⁾ X manufacturer's designation in the ID code, not related to the certificate

manufactured by

DELTA MOBREY LIMITED
HUDSON HOUSE ALBANY PARK,
CAMBERLEY, SURREY
GU16 7PL ENGLAND

satisfy the requirements of the standards

IEC 61508:2010 part 1+7

IEC 61511-1:2016 + IEC 61511-1:2016/AMD1:2017

IEC 62061:2005 + IEC 62061:2005/AMD1:2012 + IEC 62061:2005/AMD2:2015

for safety integrity level

up to and including SIL 2, with a tolerance of hardware faults HFT = 0 according to Route 1_H

up to and including SIL 3, with a tolerance of hardware faults HFT = 1 according to Route 1_H

and satisfy the requirements of systematic integrity

up to and including SC3 according to Route 1_S

Products	λ_{total} FIT	λ_{NE} FIT	λ_{SD} FIT	λ_{SU} FIT	λ_{OO} FIT	λ_{CU} FIT	SFF %
D21 Safety	905,321	265,723	0	138,208	451,857	49,533	92,256
D31 Safety	919,621	265,723	0	138,208	453,387	62,303	90,472

The products can be used in safety-related systems that meet the requirements up to and including SIL3. SIL verification of a security-related system is the responsibility of the system integrator.

This Certificate is issued due to manufacturer's name and address amendment and supersedes the Certificate No. 1005/CW/001 issued on 16.12.2020.

Certification scope and conditions are specified in the Annex issued on 16.12.2020, that has not been changed.

Date of issue: **12.05.2023**



Director of Certification and Conformity
Assessment Department

Jacek Niemczyk



www.udt.gov.pl



Urząd Dozoru Technicznego, 02-353 Warszawa, ul. Szczęśliwicka 34



22 57 22 100

3. DEFINITIONS AND ACRONYMS

SIL – safety integrity level. It is a discreet level of 1 out of 4 possible levels, corresponding to a range of safety integrity values, where safety integrity level 4 is the highest safety integrity level and safety integrity level 1 is the lowest safety integrity level.

SFF –safe failure fraction. Percentage of safe failure/defects which cannot cause a system failure. The higher the value, the lower the probability of a dangerous system failure.

DC – diagnostic coverage. Measure of system capability to detect failures. The ratio between detected dangerous failure rates and the all dangerous failures in the system.

PFH – probability of dangerous failure per hour.

PF_{Davg} – average probability of failure on demand. Average probability of a dangerous failure of a safety function in the operation mode on demand.

MTBF – mean time between failures. Describes the operation time between two consecutive component failures. MTBF refers to equipment reliability.

HFT – hardware failure tolerance. Equipment capability to continue to performing the required safety function despite occurring failures.

MTTR – mean time to repair. Average time between a failure occurrence and repair completion. MTTR includes the time necessary to detect a failure, begin and complete a repair.

MRT – expected total repair time (does not include time for fault detection).

FMEDA – failure modes effects and diagnostics analysis. Detailed analysis of different emergency modes and equipment diagnostic capabilities.

ALARM_L – diagnostic alarm state in which I_{ALARM_L} current is lower than 3,600 mA.

FIT – failure in time. The value defined as the failure rate (λ) per billion hours.

λ – failure rate. Defines the failure rate, i.e. the number of system failures per time unit.

λ_{SD} – failure rate of safe detectable failures.

λ_{SU} – failure rate of safe non-detectable failures.

λ_{DD} – failure rate of dangerous detectable failures.

λ_{DU} – failure rate of dangerous non-detectable failures.

λ_{NE} – failure rate of failures with no effect.

λ_{total} – failure rate of failures (total of all component failure rates).

4. GENERAL INFORMATION

The safety function of the **D21-Safety** and **D31-Safety** transmitters is the measurement of pressure and differential pressure of gases, vapours and liquids with the assumed precision and accuracy. This measurement controls the current proportionally in a 2-wire current loop 4...20 mA and is additionally displayed in standardised units on the local LCD indicating instrument.

The standard, intrinsically safe Exi (IS), flameproof Exd (XP) versions of **D21/D31 Safety** series transmitters are used for measurement in systems ensuring the **SIL2** safety integrity level in accordance with **PN-EN 61508:2010**.

4.1. Technical parameters

Power supply		Ambient temperature	Alarms	
Exi (IS) version	11,5 ÷ 30 V DC	-40 ÷ 85°C* (min; max)	internal diagnostic	low (LO) < 3,6 mA
Standard, Exd (XP) version	11,5 ÷ 36 V DC		critical	low (LO) << 3,6 mA

* For intrinsically safe versions, due to possible limitations of ATEX standard, the maximum operating temperature for classes T4, T5, T6 may differ from the assumed +85°C.

The other technical parameters are included in the **User's Manual**.

5. Description of safety requirements and restrictions

Under the following operating conditions, the safety function is not guaranteed:



- during configuration;
- when HART® multidrop is active;
- during transmission of measured values through HART protocol;
- during simulation;
- during immunity tests;
- when write protect is disabled.

The transmitter configured to operate in a functional safety loop after the necessary settings related to its identification, metrology and alarm modes **must** be set to locked data saving to the transmitter by means of the HART protocol, made via a communicator unit or Raport 2.

HART® is a registered trademark of FieldComm Group.

The acceptable FMEDA safe measurement error margin is: **1%**.

Duration of a full diagnostics cycle: **1 minute**.

Lifetime: **50 years**, determined based on component wear.

The lifetime does not apply to process connections (wetted elements).

5.1. Alarms

The D21/D31 Safety series transmitters are fitted with an alarm system activated when hazardous conditions are detected by internal diagnostics.

The transmitter diagnostics detects the following hazardous conditions:

- too low transmitter power supply voltage;
- pressure measurement bridge failure consisting in short circuit, open-circuit or a change in the value of one of the bridge piezoresistive sensors;
- failure of a pressure measurement bridge consisting in the short-circuit or separation of bridge bonds;
- failure consisting in a short-circuit or an open circuit of any of the connections of the pressure measuring bridge with an ADC transducer;
- failure of the ratiometric references or their excessive drift;

- failure of components or connections between them in ADC measuring circuit, coefficients memory related to linearization / head compensation, power supply in the measuring area of a pressure sensor;
- failure of components or connections between them in D/A and U/I processing path;
- pressure overload states of the measuring structure;
- failure of the digital signal transmission path through a galvanic barrier;
- failure of individual functional parts of CPU such as RAM, FLASH, registers, hardware support unit for floating-point calculations, I/O peripherals;
- failure of the integrity of the CPU programme execution;
- exceeding the permissible difference between the set-point (process) current and measured current in the 4...20 mA loop;
- exceeding threshold temperatures: pressure measurement bridge, ADC transmitter, CPU;
- exceeding the minimum or maximum operating temperature (ambient temperature);
- exceeding the threshold values of the power supply in the transmitter circuits.

If, as a result of cyber-attack, the threshold number of unauthorized access attempts to change the password or write protection is exceeded, an alarm will be triggered in the transmitter. Access to the lockout disable function is protected by the 32-bit password (4,3 billion combinations). After 20 unauthorized access attempts, an alarm is triggered until the transmitter software or hardware reset.

Some diagnostics have trigger thresholds that eliminate stochastic events in favour of correlated events. This applies in particular to possible effects of EM noise on digital transmission in the areas of the SPI bus and in the area of galvanic isolation signal amplifiers.

The transmitter diagnostics shall **not detect** the following:

- loss of tightness of the pressure system of a process connection;
- oil leakage from a pressure / differential pressure sensors or separators caused by perforation of a sensor diaphragm;
- effect of hydrogen particle penetration into sensor or separator space and a resulting measurement error;
- excessive vibrations or impacts, unless resulting in destructions of internal components or electrical connections.

Due to the nature of the power supply and the electrical interface of the transmitter, an alarm current level is used for signalling alarm states.

In the diagnostic alarm mode, the transmitter shall issue the nominal current with values: **I_ALARM_L = 3,600 mA – E**, where E is assumed in FMEDA, an acceptable 1% safe fault, equivalent to $\pm 160 \mu\text{A}$ DC in current of current loop. Finally, the rated current set point in the ALARM_L mode should be 3,440 mA.

Transmitter diagnostics does not apply current alarm mode above the range of 20,500 mA. From the point of view of PLC, current above 20,660 mA shall be considered FAIL_SAFE and a safe diagnosable failure.



Diagnostic alarms are permanently attached and are not configurable.

In case of critical alarms, the control is immediately transferred to an infinite loop triggering an independent WDT_SIL watchdog with a time discriminator. Within max. 2 seconds WDT_SIL will disconnect the transmitter's main electronics from the power supply causing a drop of current below 0,3 mA. This condition will continue until the transmitter is fully disconnected from the power and it is reconnected.

The causes of critical alarms are:

- error of floating-point mathematical calculations;
- RAM memory failure detection;
- FLASH memory failure detection;
- CPU registry error detection;
- 8 successive measurements of the current loop value nonconforming with the set value;
- disturbance of the program automaton resulting in exceeding the WDT_SIL refresh time window.

Diagnostic alarm states (except critical) can be read via **HART** communication. The **HART CMD_48** (Read Additional Transmitter Status) command allows for more accurate identification of the alarm cause.

In addition to diagnostics read via HART, diagnostic states are signaled on the local LCD display. Diagnostic alarms in individual functional blocks are logically aggregated in cumulated failure status, which can be displayed in numerical form on the local LCD display.

5.2. Restrictions

The restrictions on the use of the D21/D31 Safety series transmitters in functional safety systems include the following:

- the measuring transmitter **must** be adapted to the application considering the characteristics of the process medium and the operating ambient conditions.
- the permissible operating ranges specified in the transmitter Technical Information **must not be exceeded**.
- a faulty transmitter must be replaced **immediately** after a failure is found.

5.3. Notes on cybernetic security

Industrial control systems that have already worked as isolated systems are now based on open platforms, have contact points with an enterprise data communication system and use communications, via public Internet or most often poorly protected networks. Considering cyber security after making the necessary transmitter settings related to its identification, metrology and alarm modes, the following transmitter interlocks must be enabled:

- remote (by HART) write protection against parameter changes;
- local parameter changes using local MENU buttons.

After configuring and commissioning the functional safety system, use only the analogue current output signal. The responsibility for cybersecurity rests with the system operator who must provide a safe connection between the E/E/PE safety-related system and the plant network. The operator shall establish and maintain any appropriate means of authentication, encryption and installation of any appropriate software to protect the automation system against any security breach, unauthorized access, tampering, intrusion, corruption or data theft.

Delta Mobrey Ltd. and its subsidiaries shall not be liable for any damages and/or loss related to such safety breaches, such as unauthorized access, tampering, intrusion, break-in, data or information leak and/or theft.

6. Safety function tests

6.1. Proof Test

It is recommended to carry out safety function tests (Proof Tests) to detect 100% of possible non-diagnosable dangerous transmitter failures.

The manufacturer recommends the interval of periodic tests $T[\text{Proof}] = 1$ year.

The safety function test is performed using the **D-SOFT** software with the **SIL PROOF TEST** plugin, developed by DELTA MOBREY LTD

List of Proof Test steps:

1. Configure the PLC operating in the safety loop in a mode enabling to skip measurements and alarms from the transmitter used in the test.
2. Check the condition of the transmitter mechanical covers (no loosening, leaks) and replace any hardened or damaged gaskets and glands determining casing tightness.
3. Check the condition of electrical connections (reliability of wire connections to switching terminals).
4. Check the condition of the connection line (replace the cable if the insulation is worn). Check visually the condition of the measuring head; remove any deposit on the measuring head diaphragm by dissolving it using chemicals that will not cause diaphragm deterioration. Do not clean the measuring diaphragm mechanically. If there are traces of corrosion on the head stub pipe or on the diaphragm, contact the manufacturer in order to replace the head or use other, more resistant materials for the head for this application.
5. Run **D-Soft** software developed by DELTA MOBREY Ltd on a WINDOWS® PC. Connect a HART/USB modem manufactured by DELTA MOBREY Ltd to the computer or another BELL 202 modem. Connect the power supply, the modem and ammeter to the power loop of the tested transmitter in accordance with the diagram in **Fig. 1**. Make sure to remove the jumper for testing and re-install the jumper after test completion. The transmitter shall be supplied with a voltage of 16,50 V DC measured at the power supply unit terminals.

Identify the transmitter and open the “**SIL Proof Test**” tab. Remove software write protection to the transmitter using a HART command. For this purpose, select the “Write lock” in the “**SIL Proof Test**” tab. The operation wizard is running. Follow the instruction of the wizard which in the next steps will ask about operator’s intentions and perform the necessary actions.

WINDOWS® is a trademark of Microsoft Corporation.

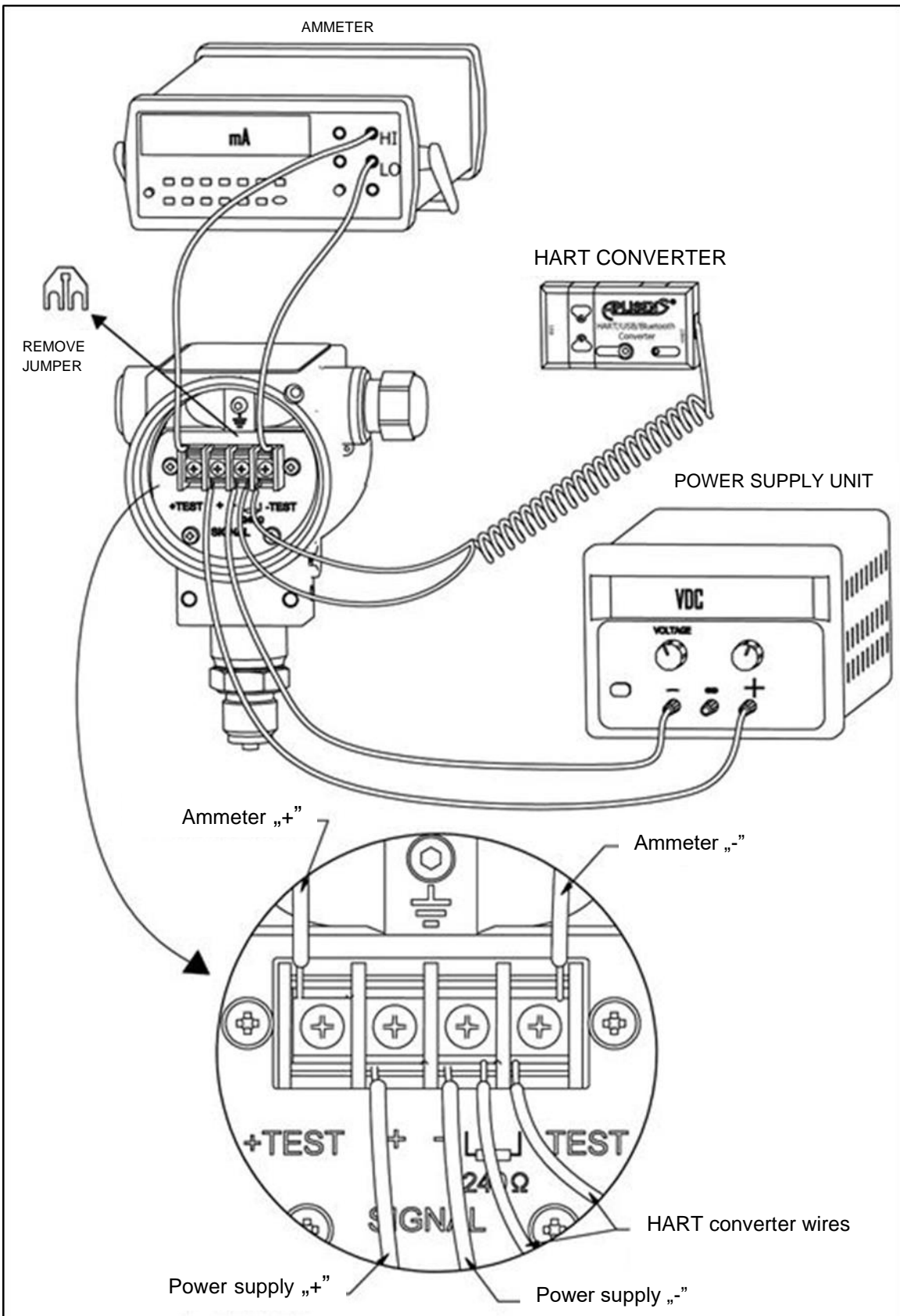

Fig. 1. Transmitter connection to the current loop for verification testing

6. Perform the tests of the current loop analogue output. For this purpose, select the “**Analog Output Test**” option on the “**SIL Proof Test**” tab. The test wizard is running. Follow the wizard’s instructions which in next steps will perform tests of the digital-analogue transducer, U/I transducer tests and tests of the current loop current control circuit.

The wizard will recommend as follows:

- 6.1. Supply the transmitter with 16,50 V DC measured at the power supply unit terminals. Using a HART command, the transmitter current output is set to 20,660 mA corresponding to the maximum safe transmitter current. Using a direct current reference milliammeter of class $\leq 0,025$ and with internal resistance of $\leq 10 \Omega$ connected to the current loop read the current flowing in the line. This test, in addition to checking the alarm current value, detects any problems related to the minimum supply voltage of the transmitter’s power supply, which may be caused by voltage drops on the power line resistance or the power source resistance.
- 6.2. When the current output is set to 20,660 mA, the test wizard reads the **PViret** parameter. The permissible deviation of the **PViret** parameter is $\pm 0,032$ mA.
- 6.3. Using a HART command, the transmitter current output is set to 3,280 mA corresponding to the LO alarm current (minus the permissible error of 1%, i.e. 0,16 mA). Using a direct current reference milliammeter of class $\leq 0,025$ connected to the current loop read the current flowing in the line. This test detects any problems related to excessive idle current drawn by the transmitter (e.g. due to a component failure).

If the current measured in test **6.1**, **6.2** or **6.3** deviates respectively from the expected values (taking into account the permissible deviation stated in the user’s manual), the analogue output should be calibrated – current for 4 mA and 20 mA. The calibration procedure shall be performed using a direct current reference milliammeter of class $\leq 0,025$ and with internal resistance of $\leq 10 \Omega$. After calibration, retest performing the steps of section **6**.



If, despite the calibration performed, the measured current value in points 6.1, 6.2 or 6.3 deviates from the expected value (taking into account the permissible deviation as stated in the user’s manual), **the test is not completed successfully, and the transmitter must be returned to the manufacturer for repair.**

7. Check the pressure / differential pressure measurement function. For this purpose, on the “**SIL Proof Test**” tab select the “**Pressure / differential pressure measurement test**” option. The test wizard is running. Wizard will carry out the pressure tests in the next steps, follow its instructions:
- 7.1. Supply the transmitter with 16,50 V DC measured at the power supply unit terminals. Using a pressure calibrator of class $\leq 0,03$, supply a reference pressure of 4 mA (0% of the set pressure) to the pressure transmitter and, using a milliammeter of class $\leq 0,025$ and an internal resistance of $\leq 10 \Omega$, measure the current flowing in the current loop.
- 7.2. Using a pressure calibrator of class $\leq 0,03$, supply a reference pressure of 12 mA (50% of the set pressure) to the pressure transmitter and, using a milliammeter of class $\leq 0,025$ and an internal resistance of $\leq 10 \Omega$, measure the current flowing in the current loop.
- 7.3. Using a pressure calibrator of class $\leq 0,03$, supply a reference pressure of 20 mA (100% of the set pressure) to the pressure transmitter and, using a milliammeter of class $\leq 0,025$ and an internal resistance of $\leq 10 \Omega$, measure the current flowing in the current loop.

If the measured values of the current deviate from the expected value, which should be within the range of $\pm 0,012$ mA (taking into account the permissible deviation as stated in the user’s manual), the pressure calibration procedure of the transmitter should be carried out for the set reference pressure values corresponding to the beginning and end of the set (or basic) range. In this case, after calibration, repeat the test starting from **section 7**.



If, when the calibration procedure has been performed correctly, the transmitter measurement continues to show a current value deviating from the expected value (taking into account the permissible deviation as stated in the user's manual), **the transmitter must be returned immediately to the manufacturer for repair.**

8. Supply the transmitter with 16,50 V DC measured at the power supply unit terminals. Check the temperature measurement of the pressure sensor structure, the ADC and the main microcontroller. For this purpose, after stabilising thermal conditions at a temperature of 15 - 25°C, measure the temperature of the transmitter body with a reference electronic thermometer of at least "B" class. "Stable thermal conditions" shall be understood as ensuring the uniform temperature of the transmitter body and the integrated pressure sensor, as far as possible. On the "**SIL Proof Test**" tab select the "**Temperature tests**" option. The test wizard is running. Follow the instructions of the wizard, which will carry out the temperature tests in the next steps. The software will read 2nd, 3rd and 4th process variable (SV, TV, FV). They correspond to the temperatures of the pressure sensor (SV), the main microcontroller (TV) and the ADC (FV) transducer.



If the SV, TV, FV temperature values deviate by more than 5°C from the temperature measured with the reference electronic thermometer during the correct test procedure, **the transmitter must be sent back to the manufacturer for repair immediately.**

9. Supply the transmitter with 16,50 V DC measured at the power supply unit terminals. Check the alarm modules for function. On the "**SIL Proof Test**" tab select the "**Alarm modules test**" option. The test wizard is running. Follow the instructions of the wizard, which will carry out the primary and backup alarm modules tests in the next steps.



If the transmitter fails to behave as described in the test wizard during the correct test procedure, **it must be immediately returned to the manufacturer for repair.**

10. Set the software write protection to the transmitter using a **HART** command (D-Soft software developed by DELTA MOBREY Ltd). For this purpose, select the "Write lock" in the "**SIL Proof Test**" tab. The operation wizard is running. Follow the instruction of the wizard which in the next steps will ask about operator's intentions and perform the necessary actions. After successful test completion, the test wizard will generate a test report and set the transmitter to the stand-by mode for connection to the functional safety loop.
11. Configure the PLC operating in the safety loop in a mode enabling to read measurements and alarms from the transmitter used in the test. Record and archive the test results.

See **Appendix 1** to safety manual for the Verification Test (**Proof Test**) checklist.

6.2. Block diagram of the Verification Test (Proof Test)

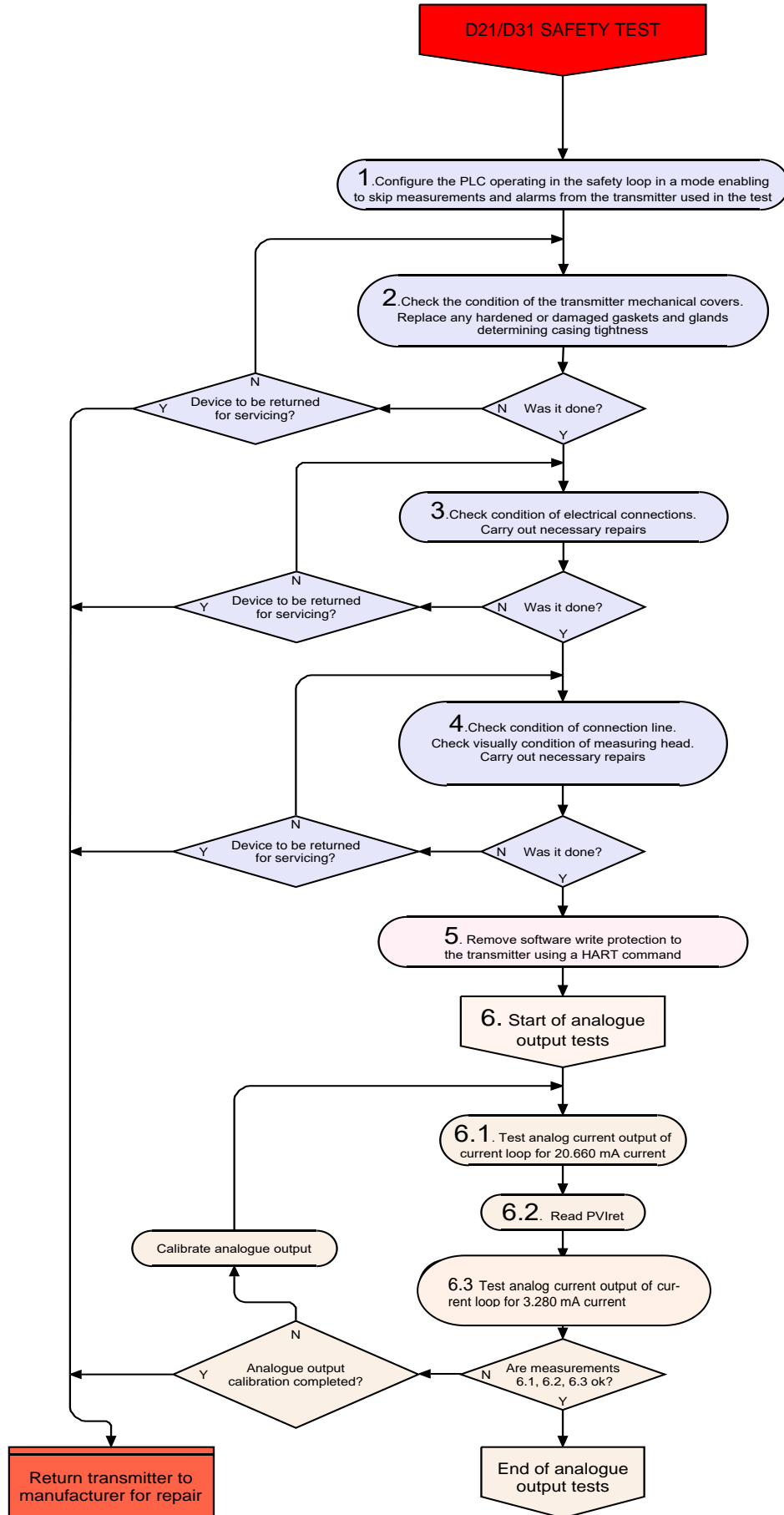

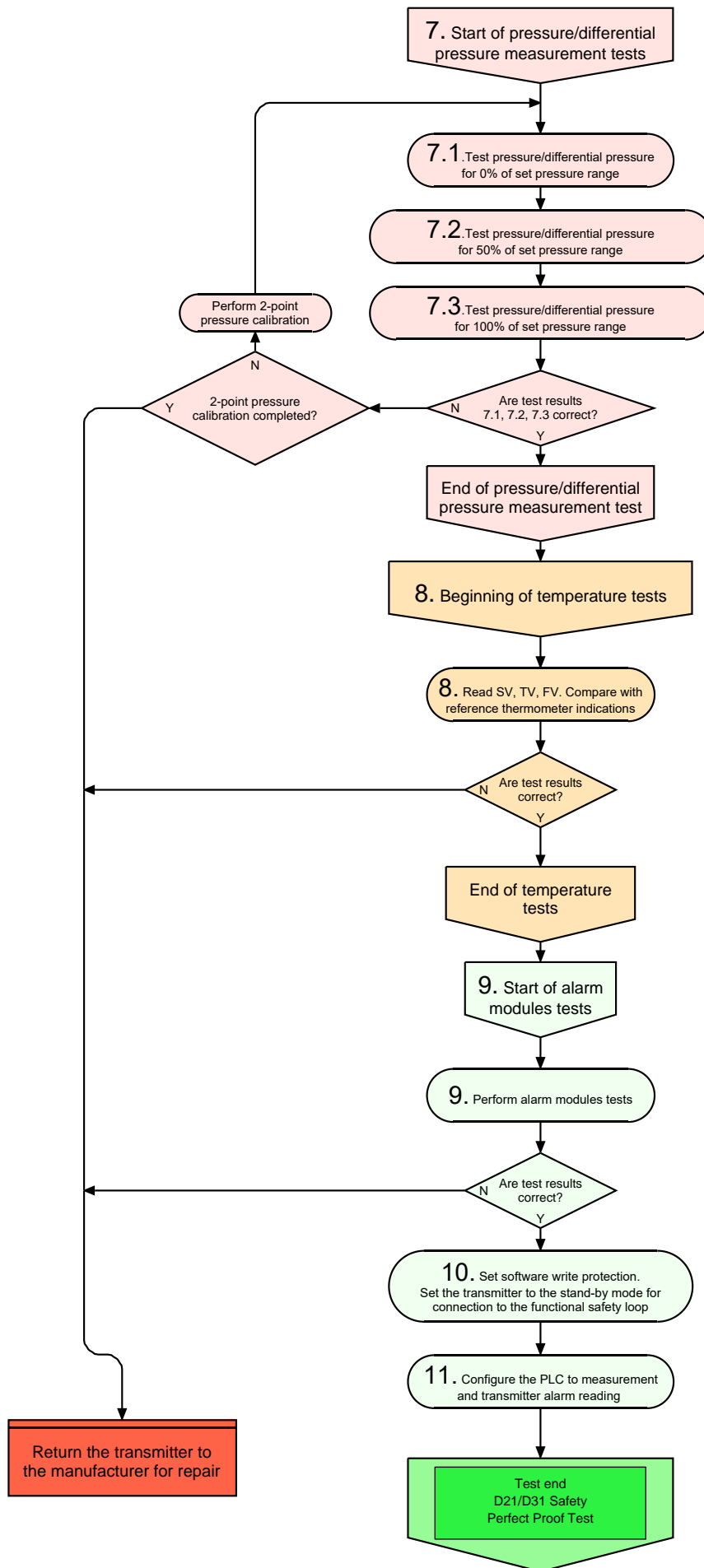

7. Repair

No repairs or alterations to the transmitter electronic system are permitted. Failure assessment and repair may only be performed by the DELTA MOBREY LTD service center. The safety functions cannot be guaranteed in the event of any unauthorized repair.

8. Reliability data

Products	λ_{total} FIT	λ_{NE} FIT	λ_{SD} FIT	λ_{SU} FIT	λ_{DD} FIT	λ_{DU} FIT	SFF %	DC %	MTBF
D21 Safety	905,321	265,723	0	138,208	451,857	49,533	92,256	90,121	1,105 x 10 ⁶ h 126,094 Yrs
D31 Safety	919,621	265,723	0	138,208	453,387	62,303	90,472	87,919	1,087 x 10 ⁶ h 124,133 Yrs

Products	T[Proof] = 1 year	T[Proof] = 2 years	T[Proof] = 5 years	T[Proof] = 10 years
D21 Safety	$\text{PFD}_{\text{avg}} = 2,17 \times 10^{-4}$	$\text{PFD}_{\text{avg}} = 4,34 \times 10^{-4}$	$\text{PFD}_{\text{avg}} = 1,08 \times 10^{-3}$	$\text{PFD}_{\text{avg}} = 2,17 \times 10^{-3}$
D31 Safety	$\text{PFD}_{\text{avg}} = 2,73 \times 10^{-4}$	$\text{PFD}_{\text{avg}} = 5,46 \times 10^{-4}$	$\text{PFD}_{\text{avg}} = 1,36 \times 10^{-3}$	$\text{PFD}_{\text{avg}} = 2,73 \times 10^{-3}$

Systematic Capability	SC 3 (SIL 3 Capable)
Random Capability	Type B Element SIL2@HFT=0; SIL3@HFT=1; Route 1 _H

$$\text{PFH} = \lambda_{\text{DU}}$$

$$\text{MTTR} = \text{MRT} = 8\text{h}$$

For the above products, the manufacturer recommends the following interval of periodic tests:
T[Proof] = 1 year.

9. History of revisions

Revision No.	Document revision	Date	Description of changes
-	014.004.001	12-03-2019	First issue, developed by KBF.
1	01.A.001 014.004.002	19-03-2019	Cybersecurity information added, developed by KBF.
2	01.A.002 014.004.003	01-04-2019	Information on cyber-attacks was added in the checklist, developed by KBF.
3	01.A.003 014.004.004	15-04-2019	QR codes added, developed by KBF.
4	01.A.004 014.004.005	15-05-2019	QR codes changed, developed by KBF.
5	01.A.005 014.004.006	28-05-2019	Changed the declaration of conformity, developed by KBF.
6	01.A.006	06-06-2019	Addition of the SIL certificate, change the declaration of conformity in accordance with the certificate, developed by KBF.
7	01.A.007	29-08-2019	SIL Declaration of Conformity changed, developed by KBF.
8	01.A.008	01-07-2020	Editorial changes. Developed by DBFD.
9	01.B.001	27-04-2023	Editorial changes, change of QR codes and ID numbers due to the update of explosion-proof certificates. Developed by DBFD.

Appendix 1. Checklist for Verification Test (Proof Test)

Test start date: _____

Person conducting the test: _____

1. Configure the PLC operating in the safety loop in a mode enabling to skip measurements and alarms from the transmitter used in the test.

completed? **Y/N** []

2. Check the condition of the transmitter mechanical covers (no loosening, leaks) and replace any hardened or damaged gaskets and glands determining casing tightness.

completed? **Y/N** []

3. Check the condition of electrical connections (reliability of wire connections to switching terminals).

completed? **Y/N** []

4. Check the condition of the connection line (replace the cable if the insulation is worn).

completed? **Y/N** []

Check visually condition of measuring head. Remove any deposit on the measuring head diaphragm by dissolving it using chemicals that will not cause diaphragm deterioration.

completed? **Y/N** []

5. Remove software write protection to the transmitter using a HART command.

completed? **Y/N** []

COMMENTS:

6. Perform the tests of the current loop analogue output.

6.1. Test analog current output of current loop for 20,660 mA current.

completed? **Y/N** []

6.2. Read PVIret for 20,660 mA current.

completed? **Y/N** []

6.3. Test analog current output of current loop for 3,280 mA current.

completed? **Y/N** []

Are test results correct? **Y/N** []

Calibration completed? **Y/N** []

COMMENTS:

7. Perform pressure / differential pressure measurement tests.

7.1. Perform the test for 0% of the set pressure range.

completed? **Y/N** []

7.2. Perform the test for 50% of the set pressure range.

completed? **Y/N** []

7.3. Perform the test for 100% of the set pressure range.

completed? **Y/N** []

Are test results correct? **Y/N** []

Calibration completed? **Y/N** []

COMMENTS:

8. Perform temperature tests by reading SV, TV, FV and comparing with indication of the reference thermometer.

Are test results correct? **Y/N** []

COMMENTS:

9. Perform alarm modules tests (tests also include alarms caused by cyber attacks).

Are test results correct? **Y/N** []

COMMENTS:

10. Check the correct setpoint of the pressure unit.

completed? **Y/N** []

Check the setting of the type of processing characteristic for correctness.

completed? **Y/N** []

Check that the setting of the start and end of the set pressure range is correct.

completed? **Y/N** []

Check that the time constant setting is correct.

completed? **Y/N** []

Check the pool-address of the instrument (should be equal to zero – analogue operation).

completed? **Y/N** []

Check the configuration of the analogue output – operation mode and type of alarm current “L”.

completed? Y/N []

Set the software write protection in the transmitter.

completed? Y/N []

COMMENTS:

11. Configure the PLC to measurement and transmitter alarm reading by connecting it to the functional safety loop.

completed? Y/N []

COMMENTS:

Date of test completion and tester’s signature:

.....
Date

.....
Signature