

Technical Datasheet



Level Switch Series

Ultrasonic Level Switch

Model: 003

Key Features

- Relay or solid-state output
- Corrosion resistant PPS construction
- 1-in. or 3/4-in. threaded mounting
- Small in-tank dimensions
- 24 Vac or dc powered
- Lightweight
- No moving parts

Series Overview

The 003 sensor is a highly reliable level switch with no moving parts.

Comprising a one piece molded body with an integral PCB, the 003 Level Switch is factory sealed and supplied with a flying lead for customer connection.

The sensor is designed for high or low level alarm duties to give a voltage free contact or solid state transistor output for alarm signaling or as part of a pump control system.

Other products

Other products we can offer :

- Ultrasonic GAP sensors
- Mechanical level switches



Product applications

- Low level alarms in header tanks
- Pump control duty in feeder tanks
- High or low alarms in storage tanks
- Level or pump control in storage tanks
- Small or thin wall tanks
- Bund level detection
- Steering gear oil
- Chemical and water treatment applications

How can we help you?

Delta Mobrey offers fast, efficient and knowledgeable support when and where you need it. Please visit our web site at www.delta-mobrey.com to find your local support centre or call us on:

+44 (0)1252 729140

How to order

Switches can be configured by selecting codes representing the desired features from the tables that follow. The chart below, describes how the model code is built up. For assistance in configuring a switch that best suits your needs, please contact your local sales office.

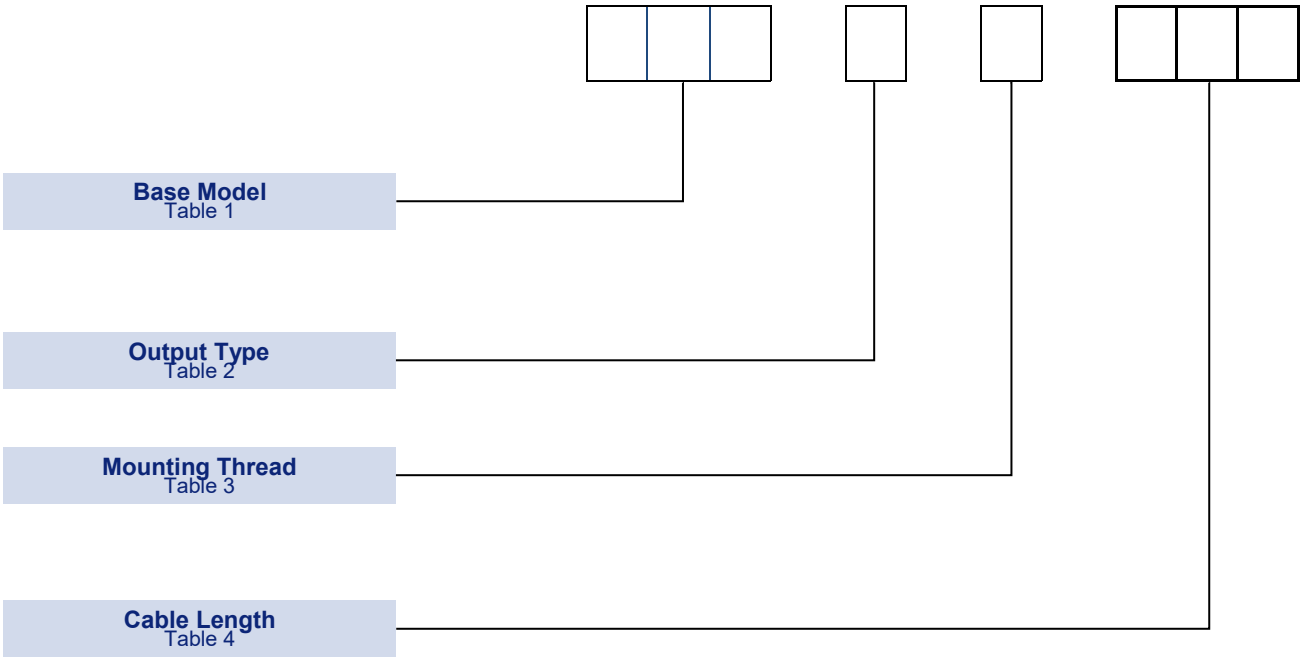

Models

For standard applications up to 5 bar (72psi)

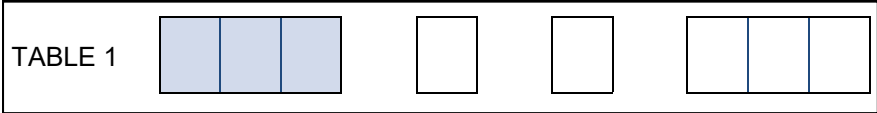

Description	Code
General Purpose The body is Polyphenylene Sulphide (PPS), with weather protection not less than NEMA type 6P, IP66/IP68.	003

Output Type

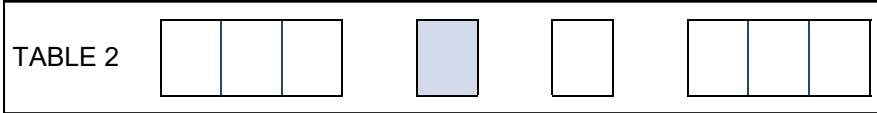

Description	Code
Integral SPCO relay (energised when sensor is wet)	S
Two open-drain FET transistors (one conducting when sensor is wet; and the other conducting when the sensor is dry)	H

Mounting Thread

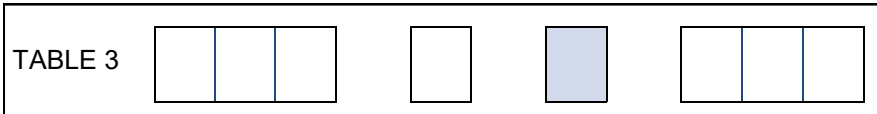

Description	Code
3/4-in. BSPT dual	0
1-in. BSPT dual	2
1-in. NPT dual	5

Cable Length

3 metres minimum, 50 metres maximum

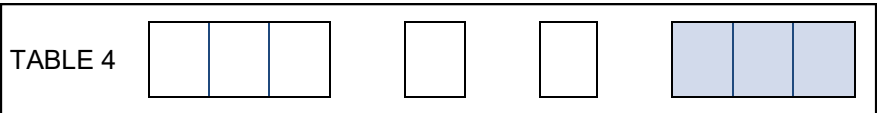

Description	Code
PVC sheathed, 10 ft. (3 m), 5-core 7 / 0.2 mm	/M03
PVC sheathed, --ft. (-- m), 5-core 7 / 0.2 mm	/M--

Level Switch Series
Model: 003

Special Engineering

For these instruments, we have many other options already designed and configured, for example:

- Carbon Fibre body.
- Alternative cables, including low smoke or halogen free.
- Sensor with the relay output energized dry.

Other options can also be designed to meet specific requirements of an application. Please contact us for further information.

Technical Specification

003 ULTRASONIC TYPE SWITCHES	003S	003H
	Operating Pressure 5 Bar (72.5psi) Ambient and Operating Temperature -20 to 70°C (-4 to 158°F) Minimum Specific Gravity 0.50 Maximum Viscosity 5000Cst at 20°C (68°F) Switching response 50ms dry/wet, 0.5s wet/dry Hysteresis <4mm (0.12 in.) Repeatability +/- 2mm (0.08 in.) Switching function SPCO relay (energized Wet) Maximum switching current 1A resistive, 0.2A inductive Maximum switching voltage 30V Power Supply 18 to 30 Vdc/ac Current drawn when dry 10mA nominal Current drawn when wet 25mA maximum IP rating IP66/68 (3m) – NEMA 6P (10ft) Cable 5-core 7/0.2mm PVC sheathing Overall Length 110 mm (4.33 in.) Length into Tank 79 mm (3.11 in.) Body Diameter 22 mm (0.87 in.) Weight (with 3m of Cable) 0.2 kgs	Operating Pressure 5 Bar (72.5psi) Ambient and Operating Temperature -40 to 105°C (-40 to 221°F) Minimum Specific Gravity 0.50 Maximum Viscosity 5000Cst at 20°C (68°F) Switching response 50ms dry/wet, 0.5s wet/dry Hysteresis <4mm (0.12 in.) Repeatability +/- 2mm (0.08 in.) Switching function 2 x FET open drain (short circuit protected). Maximum switching current 100mA max Maximum switching voltage 30V Power Supply 18 to 30 Vdc/ac Current drawn when dry 8mA nominal (4mA minimum) Current drawn when wet 16mA nominal (20mA maximum) IP rating IP66/68 (3m) – NEMA 6P (10ft) Cable 5-core 7/0.2mm PVC sheathing Overall Length 110 mm (4.33 in.) Length into Tank 79 mm (3.11 in.) Body Diameter 22 mm (0.87 in.) Weight (with 3m of Cable) 0.2 kgs

Approvals

EUROPEAN DIRECTIVES



Electromagnetic Compatibility Directive (EMC) 2014/30/EU.

This product is compliant with the directive. EN 61326-1:2013

Restriction of Hazardous Substances Directive (RoHS) 2011/65/EU.

This product is compliant with the directive

Low voltage Directive (LVD) 2014/35/EU.

This product is outside the scope of the directive as it designed for a voltage less than 50Vac and 75Vdc.

Pressure Equipment Directive (PED) 2014/68/EU:

This product is outside the scope of the directive as it does not enclose a volume (Pressure Equipment Directive Guideline, A-40)

Dimensions

Figure 1. 003S* Schematic

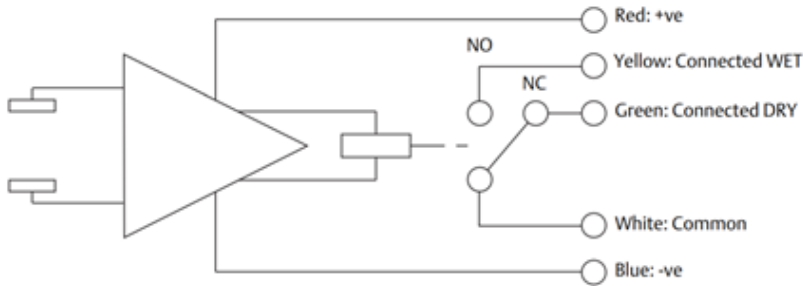
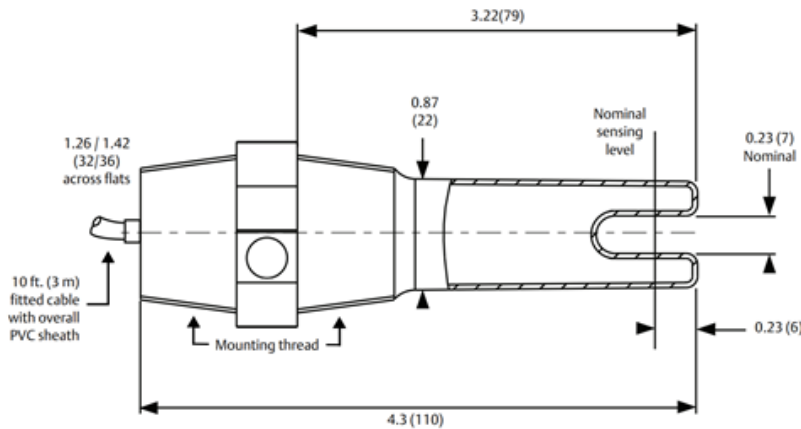
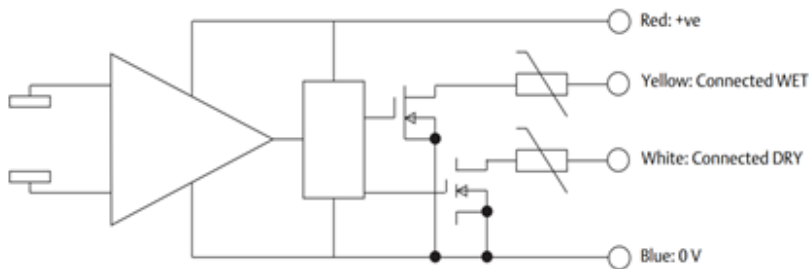

Figure 2. 003H* Schematic



Dimensions are in inches (mm) unless otherwise stated.

Level Switch Series
Model: 003

In the interest of development and improvement Delta Mobrey Ltd. reserves the right to amend, without notice, details contained in this publication. No legal liability will be accepted by Delta Mobrey Ltd for any errors, omissions or amendments.

Delta Mobrey Limited
Riverside Business Park, Dogflud Way, Farnham, Surrey GU9 7SS, UK.
T+44 (0)1252 729140 F+44 (0)1252 729168 E sales@delta-mobrey.com W www.delta-mobrey.com



ISO9001
FM00720