

How to order

Switches can be configured by selecting codes representing the desired features from the tables that follow. The chart below, describes how the model code is built up. For assistance in configuring a switch that best suits your needs, please contact your local sales office.

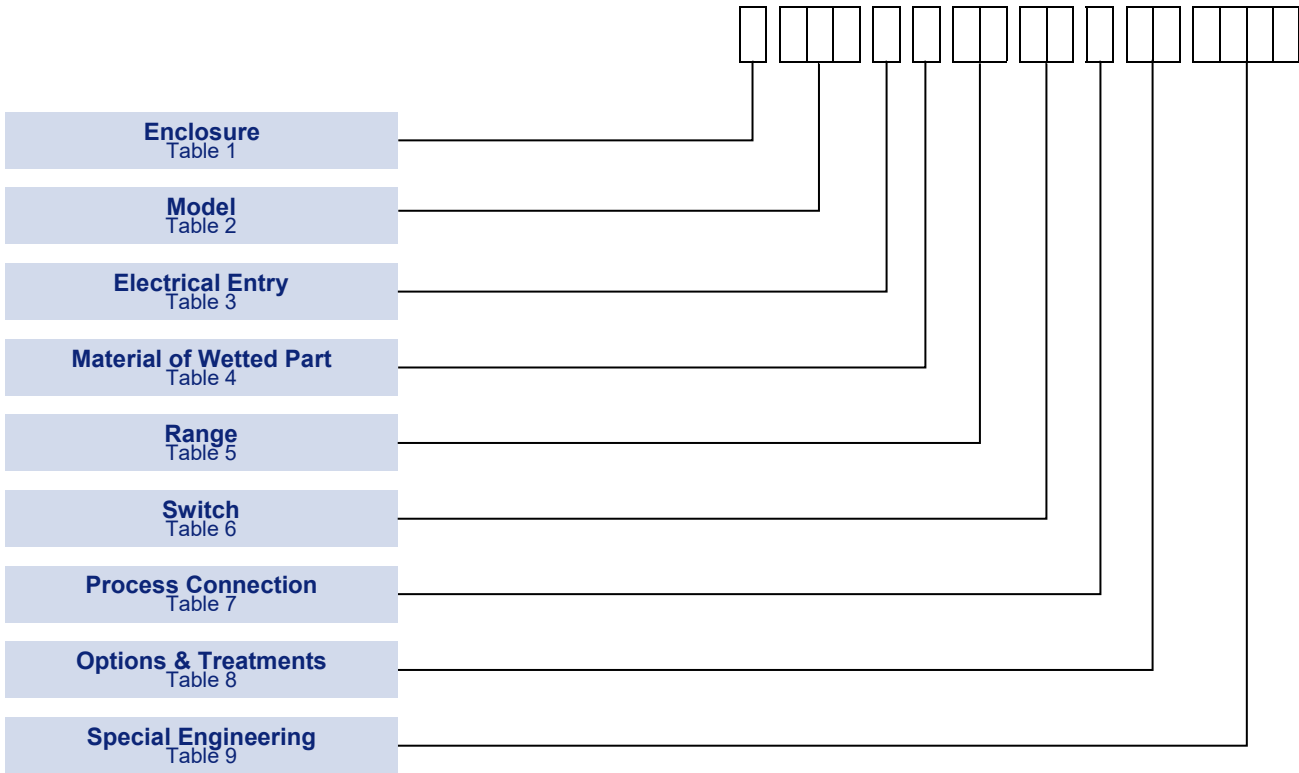

NOTE: Options shaded in the following tables are the most common options and are available on the quickest lead-times and at the lowest cost.

NOTE: Only the most common options are shown in this data sheet. Should you require a feature that is not shown, please contact your local sales office for further details.

Technical Specification

Performance Series
Models: 301, 303, 304, 381 & 384

Accuracy:	Set point repeatability ± 1% of span at 20°C / 68°F ambient. Scale accuracy ± 3% of full scale.
Storage Temperature:	-25 to +60°C / -13 to +140°F
Ambient Temperature:	-25 to +60°C / -13 to +140°F Special build is also available for temperatures down to -60°C (-76°F)
Maximum Process Temperature:	Subject to appropriate installation practice, the component parts will withstand up to +60°C (+140°F). For process temperatures up to +120°C (+248°F), order WETTED PARTS Code R (Table 4). For higher temperatures, refer to SPECIAL ENGINEERING.
Enclosure classification:	IP66 / NEMA 4X / Flameproof Ex d
Switch output:	SPDT or DPDT snap action microswitch (standard) Hermetically sealed (optional)
Electrical rating:	See Table 6
Process Connection:	Rc 1/4 (BSP), 1/4 NPT Internal, 1/2 NPT Internal & 1/2 NPT External
Approximate Weight:	Enclosures: “ W & N ” 4.5kg / 9.9lb; “ A & O ” 6.4kg / 13.8lb; “ H ” 5.9kg/13.0lb; “ K ” 9.7kg/21.4lb; For range C6/CP add 0.4kg/0.9lb; For series 304 add 2.3kg/5.1lb.

Enclosure

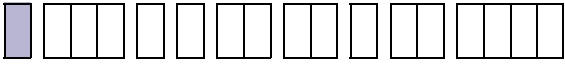
TABLE 1 

FINISH

All enclosures except Type A are finished in light grey epoxy resin paint. Special finishes to order.



INTRINSIC SAFETY

Because of the low voltages and currency of I.S. circuits, we recommend using gold and/or sealed contacts.

NOTE: Enclosure Codes W & A with range BC, C6, E1 and E8 (BU, CP, E4, E7) have weather protection reduced to IP54. In the interests of reliability not all enclosures are available with all wetted parts materials. See Table 4.

Temperatures in Table 1 refer to limitations for certified enclosures.

See **TECHNICAL SPECIFICATION**.

ENCLOSURE TYPES	Code
Weatherproof Enclosures	
General Purpose The basic enclosure is pressure die-cast in zinc alloy, offering weather protection not less than NEMA 4 + 13/IP66.	W
For Aggressive Atmospheres Investment cast enclosure in austenitic stainless steel with weather protection not less than NEMA 4X + 13/IP66.	A
Flameproof Enclosures Category 2 (Zone 1)	
ATEX Ex db IIC T6 (-60 to +40°C), T4 (-60 to +80°C) II 2 G D Gravity die-cast enclosure in aluminium-silicon alloy. Suitable for outdoor use, IP66 / NEMA 4.  II 2 G D	H
IECEx Ex db IIC	
ATEX Ex db IIC T6 (-60 to +40°C), T4 (-60 to +80°C) II 2 G D As Code H, but sand cast in high quality grey iron.  II 2 G D	K
IECEx Ex db IIC	
Exn Enclosures Category 3 (Zone 2).	
Type of Protection Exn II T6 (-25 to +40°C), T4 (-25 TO +80°C) II 3 G D As code 'W' but Exn. Weatherproof to NEMA 4/IP66. Limited switching facility (see Table 6).  II 3 G D	N
As 'N' but with investment cast enclosure in austenitic stainless steel as 'A'.	O

Models

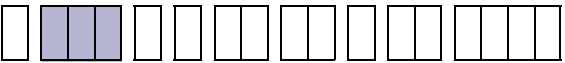
TABLE 2 

Maximum working pressures are as follow

301, 303, 381
110 bar (1600 psi)

304, 384
250 bar (3500 psi)

	Code
Fixed Switching Differential See Tables 10A & 10C. Basic model giving close, fixed switching differential using proprietary microswitch operated by high integrity stainless steel mechanism. Set point field adjustable over full range against calibrated scale. SPDT & DPDT options available.	301 304
Adjustable Switching Differential (Wide Span) See Tables 10B & 10D. Falling set point adjustable against a calibrated scale. Rising reset point adjustable to increase switching differential by up to 50% of range.	303
HI-LO Switching (Adjustable Gap) See Tables 10A & 10C. Two individual set points and separate electrical circuits, with independent adjustment against calibrated scale.	381 384

Performance Series
Models: 301, 303, 304, 381 & 384

Electrical Entry

Adaptors are available for other popular thread sizes.

Enclosures 'W' and 'N'

Standard option code 1(22mm dia) is provided with a nylon 22/20 reducer and fibre washer suitable for a standard M20 cable gland and back nut. Option code 0 elbow adaptor is factory fitted. Adaptor kits may also be provided retrospectively to fit at site if required. Ask for details. See diagrams for dimensions.

'W' and 'N' SAFETY NOTE

If a metal cable gland is site fitted it must either be earthed locally or an earth/gland plate must be used to connect the body of the gland at the enclosure earthing point. Earth/gland plates can be provided either factory fitted or in kit form for site assembly. Ask for details.

Material of Wetted Parts

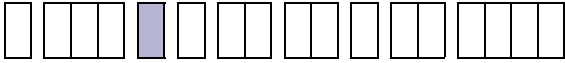
TABLE 3 

	Code
Enclosures W & N: Clearance for 20mm (3/4 in) outside dia conduit.	1
Enclosures H, K, A & O: M20 x 1.5 ISO thread (direct)	0
Enclosures H, K & O: M20 x 1.5 ISO thread, dual entry.	5
Enclosures H & K: 3/4-NPT INT.	3
Enclosures H & K: 1/2-NPT INT.	2
Enclosures H & K: 3/4-NPT INT dual entry.	6
Enclosure W: M20 x 1.5 elbow adaptor.	0
Enclosure N: M20 x 1.5 straight adaptor (Approved).	0

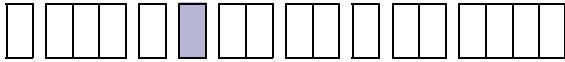
TABLE 4 

	Code
316 Stainless steel diaphragm. All other wetted parts fully austenitic 300 Series stainless steel, PTFE and Nitrile seals.	I
Nickel Alloy (Monel) diaphragm. All other wetted parts fully austenitic 300 series stainless steel. PTFE and Nitrile seals.	J
For wetted parts required to conform with Sour Gas or Sour Crude applications as laid down in NACE standard MR-01-75.	L
Nickel Alloy (Monel) diaphragm and other wetted parts. PTFE and Viton seals. (NACE).	Q
316 Stainless steel diaphragm. All other wetted parts fully austenitic 300 series stainless steel. PTFE and Viton seals.	R
Non-standard requirements	X

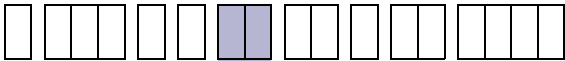
TABLE 5 

MODELS 301/303/381

P _{max}		Range			Code
bar	psi	mbar/bar	Code	In H ₂ O/psi	
0.5	7	-0.6 to +0.6	B2†	-0.25 to +0.25	B6†
1	15	-2.5 to +2.5	B3†	-1 to +1	BN†
1	15	0 to 5	B5†	0 to 2	BR†
		-12.5 to +12.5	BC*	-5.0 to +5.0	BU*
		3 to 25	C6	1 to 10	CP
		5 to 120	E1	2 to 50	E4
		50 to 350	E8	1 to 5	E7
		0.1 to 1.5	G5	1 to 20	GP
		0.2 to 4	J0*	2 to 60	J3*
		0.7 to 7	M2*	10 to 100	M8*
		1.5 to 15	P8*	20 to 200	PK*
(250)	(3500)				
OR					
SEE MODELS					

Setting Ranges

P_{max} = maximum working pressure

The instruments will sustain, without loss of performance, a continuous forward over pressure equal to the maximum static/line pressure and/or full vacuum.

NOTE: For pressure difference switches maximum working pressure (P_{max}) and maximum static/line pressure mean the same.

† Ranges B2, B3 and B5 are available with special engineering only and are not available for model 303. Contact local sales representative for these ranges.

Maximum static pressure applied in the reverse direction (i.e. to LO port with HI port to atmosphere) will be contained without failure. The diaphragm will however have been distorted, leading to a degradation of performance and a shortening of the service life.

For applications where regular reversals of pressure are inevitable, a special engineering facility is available.

MODELS 304/384

P _{max}		Range			Code
bar	psi	mbar/bar	Code	In H ₂ O/psi	
110 (250)	1600 (3500)	-12.5 to +12.5 3 to 25 5 to 120 50 to 350 0.1 to 1.5	0C*	-5.0 to +5.0 1 to 10 2 to 50 1 to 5 1 to 20	0U*
			06 01 08 G5		0P 04 07 GP
OR		0.2 to 4	J0*	2 to 60	J3*
SEE MODELS		0.7 to 7	M2*	10 to 100	M8*
		1.5 to 15	P8*	20 to 200	PK*

*Ranges BC/0C/BU/0U, J0/J3, M2/M8 and P8/PK not available on models 303, 381 and 384

Switch Options

TABLE 6

A much wider variety of switching options can be engineered to customer's requirements for Model 301 switches, including heavy DC, manual latching, pneumatic output etc. On Models 303, 381 & 384 only the switching options specified can be supplied. Please consult our engineers for further information.

Model 301, 304								
UL/CSA RATING (RESISTIVE) § see note	IEC947-5-1 / EN 60947-5-1 RATING						Contact	Code
	Designation & Utilisation Category	Rated operational current I _e (A) at rated operational voltage U _e	U _i	U _{imp}	VA Rating			
					Make	Break		
5 Amps @ 110/250V AC Light Duty for AC only	AC14 D300 DC13 R300	0.6/0.3A @ 120/240 V AC 0.22/0.1A @ 125/250V DC	250V	0.8kV	432 28	72 28	SPDT DPDT	00 01
5 Amps @ 110/250V AC & 2 Amps @ 30V DC General purpose precision	AC14 D300 DC13 R300	0.6/0.3A @ 120/240 V AC 0.22/0.1A @ 125/250V DC	250V	0.8kV	432 28	72 28	SPDT DPDT	02 03
1 Amp @ 125V AC & § 100mA @ 30V DC Gold Alloy contacts for low voltage switching	1A @ 125 VAC RESISTIVE (IEC 1058-1 / EN 61058-1)						SPDT DPDT	04 05
§ 5 Amps @ 110/250V AC & 5 Amps @ 30V DC Environmentally sealed	AC14 D300 DC13 R300	0.6/0.3A @ 120/240 V AC 0.22/0.1A @ 125/250V DC	250V	0.5kV	432 28	72 28	SPDT* DPDT*	08 09
§ 1 Amp @ 30V AC & 30V DC Environmentally sealed with gold contacts	AC14 E150	0.3A @ 120 V AC	125V	0.5kV	216	36	SPDT* DPDT*	0G 0H
5 Amps @ 250V AC & 2 Amps @ 30V DC Hermetically sealed. Gold plated silver contacts	AC14 D300 DC13 R300	0.6/0.3A @ 120/240 V AC 0.22/0.1A @ 125/250V DC	250V	0.5kV	432 28	72 28	SPDT DPDT	H2 H3 [†] , H6 [‡]
† 2 Single pole, double throw, simultaneous falling under pressure ‡ 2 Single pole, double throw, simultaneous rising under pressure								
Model 303								
5 Amps @ 110/250V AC and 2 Amps @ 30V DC General purpose precision	AC14 D300 DC13 R300	0.6/0.3A @ 120/240 V AC 0.22/0.1A @ 125/250V DC	250V	0.8kV	432 28	72 28	SPDT DPDT	02 03
1 Amp @ 125V AC and § 100mA @ 30V DC Gold Alloy contacts for low voltage switching	1A @ 125 VAC RESISTIVE (IEC 1058-1 / EN 61058-1)						SPDT DPDT	04 05

Performance Series
Models: 301, 303, 304, 381 & 384

Model 381, 384								
UL/CSA RATING (RESISTIVE) § see note	IEC947-5-1 / EN 60947-5-1 RATING						Contact	Code
	Designation & Utilisation Category	Rated operational current I_e (A) at rated operational voltage U_e	U_i	U_{imp}	VA Rating			
					Make	Break		
5 Amps @ 110/250V AC Light Duty for AC only	AC14 D300 DC13 R300	0.6/0.3A @ 120/240 V AC 0.22/0.1A @ 125/250V DC	250V	0.8kV	432 28	72 28	SPDT	20
5 Amps @ 110/250V AC & 2 Amps @ 30V DC General purpose precision	AC14 D300 DC13 R300	0.6/0.3A @ 120/240 V AC 0.22/0.1A @ 125/250V DC	250V	0.8kV	432 28	72 28	SPDT	22
1 Amp @ 125V AC & § 100mA @ 30V DC Gold Alloy contacts for low voltage switching	1A @ 125 VAC RESISTIVE (IEC 1058-1 / EN 61058-1)						SPDT	24
§ 5 Amps @ 110/250V AC & 5 Amps @ 30V DC Environmentally sealed	AC14 D300 DC13 R300	0.6/0.3A @ 120/240 V AC 0.22/0.1A @ 125/250V DC	250V	0.5kV	432 28	72 28	SPDT*	28
§ 1 Amp @ 30V AC & 30V DC Environmentally sealed with gold contacts	AC14 E150	0.3A @ 120 V AC	125V	0.5kV	216	36	SPDT*	2G
5 Amps @ 250V AC & 2 Amps @ 30V DC Hermetically sealed. Gold plated silver contacts	AC14 D300 DC13 R300	0.6/0.3A @ 120/240 V AC 0.22/0.1A @ 125/250V DC	250V	0.5kV	432 28	72 28	SPDT	H4

The electrical rating is dependent on the microswitch fitted to the instrument. The electrical ratings defined by each approval that the microswitch complies with and is shown on the product nameplate, i.e. UL, CSA, or IEC. It should be noted that the instrument must be used within the electrical rating specified from the approval you require. This table lists the actual IEC ratings against the Designation & Utilisation Category marked on the nameplates. In the absence of any verification by CSA the microswitch § manufacturer's rating is stated in **italics and bold**. **If in doubt seek guidance from the factory.**

NOTE: For low energy circuits e.g. 30V and up to 100mA, we recommend using gold alloy contact switches.
 U_i = rated insulation voltage U_{imp} = rated impulse to withstand voltage across contacts.

*Suitable for use with Exn Enclosures (See Table 1)

Process Connection

Other thread specifications and sizes are available without using adaptors.

See DIMENSIONS.

Adaptors are available for applications where their use is permitted.

TABLE 7 

	Code
Rc 1/4 (1/4 BSP tr INT) to ISO 7/1	A
1/4—18 NPT INTERNAL	F
1/2—14 NPT INTERNAL	H
1/2—14 NPT EXTERNAL	J

Options & Treatments

Combinations available, apply for details.

TABLE 8	
---------	--

	Code
Tropicalisation High humidity atmospheres	01
Marine and Offshore Saline atmosphere or salt spray	02
Ammonia Process (wetted) parts and construction suitable for atmospheric ammonia	03
Oxygen Service 2: Process (wetted) parts are cleaned for oxygen	04
Oxygen Service 3: Process and non-process parts are cleaned for use with oxygen	05
Stainless Steel Pipe Mounting Bracket Permits local 2" pipe work to be utilized for mounting the instrument	10
Tagging - Variety of tagging methods are available	APPLY FOR DETAILS
Applies when - no option is required and selection is made from special engineering	00

Special Engineering

Last 4 digits of model code only used when special engineering is required.

TABLE 9	
---------	--

	Code
Please consult Delta sales engineering for special requirements	TBA

Performance Data

TABLE 10	
----------	--

Bar Units

TABLE 10A: 1 & 2.
MODELS 301, 304, 381, 384
FIXED SWITCHING DIFFERENTIAL

MODEL 381/384: The switching differential on each point may be up to 1.5 times that of Table 10A & 10C. Care must be exercised, therefore, in specifying high differential switches on sensitive ranges, or set point separation less than 3 times switching differential.

MODELS 301 & (381)		mbar units					TABLE 10A:1				
Range Code	Range mbar/bar	SPDT OPTIONS					DPDT OPTIONS				
		00 (20)	02 (22)	04 (24)	08/0G (28/2G)	H2 (H4)	01	03	05	09/0H	H3/H6
B2	-0.6 to +0.6	0.2	0.2	0.2	-	-	0.4	0.4	0.5	-	-
B3	-2.5 to +2.5	0.4	0.8	0.4	0.8	-	0.8	1.2	0.8	1.2	-
B5	0 to 5	0.4	0.8	0.4	1.5	1.2	0.8	1.2	0.8	1.7	1.8
BC	-12.5 to +12.5	2	6	2	5	4	4	8	4	10	20
C6	3 to 25	2	6	2	5	4	4	8	4	10	20
E1	5 to 120	4	12	4	10	12.5	8	16	8	25	50
E8	50 to 350	10	30	10	20	17.5	20	40	20	30	60
G5	0.1 to 1.5	50	150	50	90	125	100	200	100	115	230
J0	0.2 to 4	100	300	100	200	300	200	400	200	250	500
M2	0.7 to 7	200	600	200	250	400	400	800	400	300	600
P8	1.5 to 15	300	900	300	500	600	600	1200	600	600	1200

MODELS 304 & (384)		mbar units					TABLE 10A:2				
Range Code	Range mbar/bar	SPDT OPTIONS					DPDT OPTIONS				
		00 (20)	02 (22)	04 (24)	08/0G (28/2G)	H2 (H4)	01	03	05	09/0H	H3/H6
0C	-12.5 to +12.5	2	6	2	5	4	4	8	4	10	20
06	3 to 25	2	6	2	5	4	4	8	4	10	20
01	5 to 120	4	12	4	10	12.5	8	16	8	25	50
08	50 to 350	10	30	10	20	17.5	20	40	20	30	60
G5	0.1 to 1.5	50	150	50	90	125	100	200	100	115	230
J0	0.2 to 4	100	300	100	200	300	200	400	200	250	500
M2	0.7 to 7	200	600	200	250	400	400	800	400	300	600
P8	1.5 to 15	300	900	300	500	600	600	1200	600	600	1200

Performance Series
 Models: 301, 303, 304, 381 & 384

**TABLE 10B
MODEL 303
ADJUSTABLE SWITCHING
DIFFERENTIAL**

MODEL 303		mbar units				TABLE 10B			
Range Code	Range mbar/bar	SPDT OPTIONS				DPDT OPTIONS			
		02		04		03		05	
		From	To	From	To	From	To	From	To
C6	3 to 25	8	25	8	25	12	25	12	25
E1	5 to 120	15	120	15	120	22	120	22	120
E8	50 to 350	50	350	50	350	75	350	75	350
G5	0.1 to 1.5	150	750	150	750	225	750	225	750

PSI Units

**TABLE 10C: 1 & 2
MODELS 301, 304, 381, 384
FIXED SWITCHING DIFFERENTIAL**

Switching differentials in.H₂O/psi.

Due to manufacturing tolerances the figures quoted in these tables are for guidance only and are typical for weatherproof models.

Flameproof models may be up to 2 times higher depending on the range. Should the differential be critical for specific applications our engineers should be consulted prior to ordering.

MODELS 301 & (381)		PSI units					TABLE 10C:1				
Range Code	Range in.H ₂ O/psi	SPDT OPTIONS					DPDT OPTIONS				
		00 (20)	02 (22)	04 (24)	08/0G (28/2G)	H2 (H4)	01	03	05	09 0H	H3 H6
BG	-0.25 to +0.025	0.08	0.08	0.08	-	-	0.16	0.16	0.2	-	-
BN	-1 to +1	0.16	0.3	0.16	0.32	-	0.3	0.5	0.3	0.48	-
BR	0 to 2	0.16	0.3	0.16	0.6	0.48	0.3	0.5	0.3	0.68	0.72
BU	-5.0 to +5.0	0.8	2.4	0.8	2	1.6	1.6	3.2	1.6	4	8
CP	1 to 10	0.8	2.4	0.8	2	1.6	1.6	3.2	1.6	4	8
E4	2 to 50	1.6	4.9	1.6	4	5	3.2	6.4	3.2	10	20
E7	1 to 5	0.15	0.45	0.15	0.3	0.25	0.3	0.6	0.3	0.45	0.9
GP	1 to 20	0.7	2.2	0.7	1.3	1.8	1.5	2.9	1.5	1.7	3.3
J3	2 to 60	1.5	4.4	1.5	2.9	4.3	2.9	5.8	2.9	3.6	7.3
M8	10 to 100	2.9	8.7	2.9	3.6	5.8	5.8	11.6	5.8	4.4	8.7
PK	20 to 200	4.4	13	4.4	7.5	8.7	8.7	17.5	8.7	8.7	17.5

MODELS 304 & (384)		PSI units					TABLE 10C:2				
Range Code	Range in.H ₂ O/psi	SPDT OPTIONS					DPDT OPTIONS				
		00 (20)	02 (22)	04 (24)	08/0G (28/2G)	H2 (H4)	01	03	05	09 0H	H3 H6
0U	-5.0 to +5.0	0.8	2.4	0.8	2	1.6	1.6	3.2	1.6	4	8
0P	1 to 10	0.8	2.4	0.8	2	1.6	1.6	3.2	1.6	4	8
04	2 to 50	1.6	4.9	1.6	4	5	3.2	6.4	3.2	10	20
07	1 to 5	0.15	0.45	0.15	0.3	0.25	0.3	0.6	0.3	0.45	0.9
GP	1 to 20	0.7	2.2	0.7	1.3	1.8	1.5	2.9	1.5	1.7	3.3
J3	2 to 60	1.5	4.4	1.5	2.9	4.3	2.9	5.8	2.9	3.6	7.3
M8	10 to 100	2.9	8.7	2.9	3.6	5.8	5.8	11.6	5.8	4.4	8.7
PK	20 to 200	4.4	13	4.4	7.5	8.7	8.7	17.5	8.7	8.7	17.5

**TABLE 10D
MODEL 303
ADJUSTABLE SWITCHING
DIFFERENTIAL**

MODEL 303		PSI units				TABLE 10D			
Range Code	Range in.H ₂ O/psi	SPDT OPTIONS				DPDT OPTIONS			
		02		04		03		05	
		From	To	From	To	From	To	From	To
CP	1 to 10	3.2	10	3.2	10	4.8	10	4.8	10
E4	2 to 50	5	48	5	48	8.9	48	8.9	48
E7	1 to 5	0.75	5	0.75	5	1.1	5	1.1	5
GP	1 to 20	2.2	11	2.2	11	3.5	11	3.5	11

Performance Series
Models: 301, 303, 304, 381 & 384

Electrical Connections

<p>Terminal Block Cable entry is to a non-pinching terminal block made of a non-hygroscopic thermosetting plastic, suitable for cables up to 2.5mm²/14AWG.</p>
<p>Earthing/Grounding An earthing stud is provided inside all weatherproof enclosures, adjacent to the entry. External earthing is standard on flameproof versions. Safety note see Table 3.</p>
<p>Dielectric Strength The electrical assembly is capable of withstanding *2kV between live parts and earth/ground and 500V between open contacts. * 1.2kV for micro switch Codes H2, H3, H4 and H6. Refer to Table 6.</p>
<p>Electrical Entry Standard options are listed in Table 3. Other threads can be accommodated by adaptors. Dual entry available, see Table 3.</p>

Optional Extras

<p>Chemical Seals Chemical seals of our own or proprietary manufacture can be fitted when required.</p>
<p>Mounting Position/Location/Installation Vertical as shown, IN DIMENSIONS, taking care to avoid siting in locations that transmit excessive shock or vibration. For further advice contact our engineers.</p>
<p>Pollution degree (EN60947-5-1) All products are suitable for use in pollution degree 3. For extreme conditions where condensation may readily form, then sealed contacts should be used. See Table 6 Codes 08/09, 0G/0H, 2G, 28, H2/H3/H4/H6.</p>
<p>Electrical Isolation These products are not suitable for electrical isolation. Always isolate circuit separately to carry out any electrical work.</p>

Approvals

EUROPEAN DIRECTIVES



 **Low voltage Directive (LVD) 2014/35/EU.**
Compliant to LVD

Pressure Equipment Directive (PED) 2014/68/EU:
This product has a process connection size <=DN25 and is therefore categorised as sound engineering practice under Article 4 (3)

ATEX APPROVALS

 **FLAMEPROOF:**
Certificate No. BAS01ATEX2426X
EN 60079-0, EN 60079-1, EN 60079-31

For Zone 1 models (**Enclosure code H/K, see Table 1**)

	II 2 GD	Ex db IIC T4 (Tamb -60°C to +80°C) Gb
		Ex tb IIIC T135°C (Tamb -60°C to +80°C) Db IP66
	II 2 GD	Ex db IIC T6 (Tamb -60°C to +40°C) Gb
		Ex tb IIIC T85°C (Tamb -60°C to +40°C) Db IP66

GLOBAL CERTIFICATION

 **IECEX Certified**
Ex db IIC T4 (Tamb -60°C to +80°C) Gb
Ex db IIC T6 (Tamb -60°C to +40°C) Gb

Certificate No. IECEX ITS 04.0006X
IEC 60079-0, EN 60079-1

Dimensions

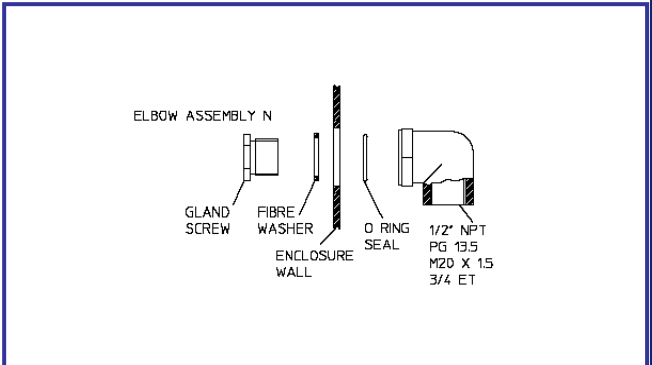
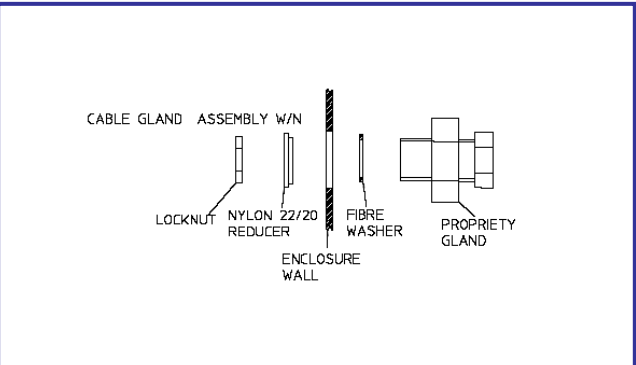

Performance Series
Models: 301, 303, 304, 381 & 384

