

Technical Datasheet



Diaphragm Operated Differential Pressure Gauges DG Range



Key Features

- Nominal Diameter of 100 mm and 150 mm
- Degree of Protection IP55/IP65/IP67
- Stainless steel enclosure as standard
- Blowout protection
- Ranges available from 0 to 25mbar, up to 0 to 25bar
- Monel pressure connection, material and options available for double diaphragm construction
- Double & single diaphragm construction depends on range & static pressure & wetted part materials

Alternative on Specials

On limited versions only, a single diaphragm construction can be manufactured with limited overpressure.

- 40 bar for ranges between 400 mbar and 25 bar. Static pressure up to 100 bar
- 10 bar for ranges between 160 mbar and 400 mbar. Static pressure up to 100 bar

Series Overview

- The DG diaphragm operates differential pressure gauges offering customers a cost effective and reliable solution to their process control requirement
- It comes in the Single and Double diaphragm construction to suit a wide range of over pressure and measuring range requirements
- Available in variety of wetted part materials, the DG differential pressure gauge can be used for variety of applications

Other products

Other products we can offer include:

- Bourdon Tube Pressure Gauges
- Double C-Bourdon Tube Differential Pressure Gauges: model DB



Product applications

The DG range is suitable for a wide range of applications in:

- Oil & Gas
- Chemical
- Petrochemical
- Refining
- Power
- Marine
- Food Industry
- OEM

The choice of models available ensures suitability for use in:

- Corrosive atmospheres
- Resistant to chemical attack

How can we help you?

Delta Mobrey offers fast, efficient and knowledgeable support when and where you need it. Please visit our website at www.delta-mobrey.com to find your local support centre or call us on:

+44 (0) 1252 729140

Diaphragm Differential Pressure
Models: DG range

How to order

Gauges can be configured by selecting codes representing the desired features from the tables that follow. The chart below, describes how the model code is built up. For assistance in configuring a switch that best suits your needs, please contact your local sales office.

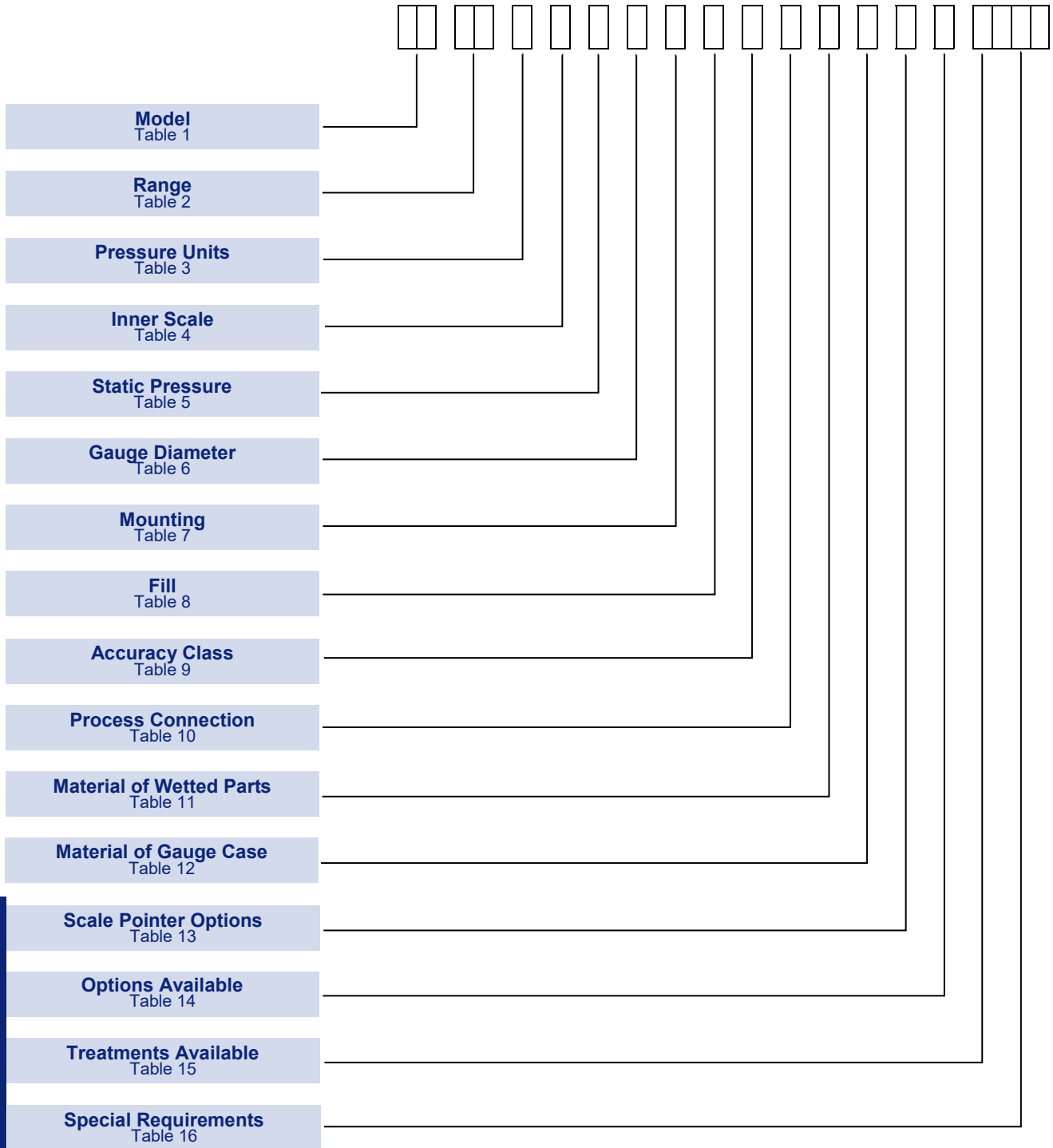

Diaphragm Differential Pressure
 Models: DG range

NOTE: Options shaded in the following tables are the most common options and are available on the quickest lead-times and at the lowest cost.

NOTE: Only the most common options are shown in this data sheet. Should you require a feature that is not shown, please contact your local sales office for further details.

Technical Specification

Enclosure casing:	IP55 Protection for dry execution IP65/IP67 Protection for filled and dry case fillable execution
Scale:	On 270° for ranges above 100 mbar
Pressure connection material:	AISI 316 stainless steel as standard
Dials:	White aluminium with black graduation
Process connection:	1/2-14 NPT, G1/2B and 1/4"NPTF
Accuracy:	Class 1.6 ($\pm 1.6\%$ of full scale deflection).
Ambient temperature:	-20 to +60 °C
Process temperature:	Max 120°C
Options:	Diaphragm Seal, Electric contact options available.

Model

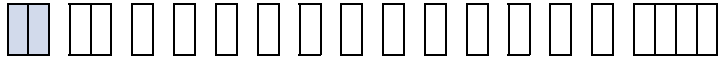
TABLE 1 

ENCLOSURE TYPES	Code
Industrial Service Differential Pressure Gauge	
100mm and 150mm	DG
ATEX certified Industrial Service Differential Pressure Gauge	
ATEX service pressure gauge - Other specification as DA  II 2 G D	DA

Range

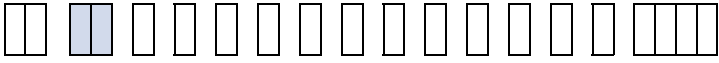
TABLE 2 

	Range	Bar	Kg/cm ²	mbar	KPa	PSI	Code
Gauge Pressure Ranges	0 to 1	√	√				DA
	0 to 1.6	√	√				DB
	0 to 2.5	√	√				DC
	0 to 4	√	√				DD
	0 to 6	√	√				DE
	0 to 10	√	√				EA
	0 to 15						DK
	0 to 16	√	√				EB
	0 to 25	√	√		√		EC
	0 to 30						DP
	0 to 40				√		ED
	0 to 60				√	√	EE
	0 to 100				√	√	FA
	0 to 160				√	√	FB
	0 to 200					√	PF
	0 to 250				√	√	FC
	0 to 300					√	ER
	0 to 400				√	√	FD
	0 to 600				√	√	FE
0 to 1000					√	GA	
0 to 1600					√	GB	
0 to 2500					√	GC	
Non standard range							XX

Diaphragm Differential Pressure Models: DG range

Pressure Units

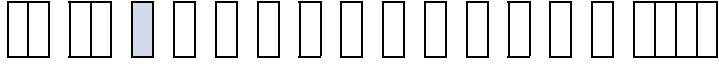
TABLE 3 

	Code
Kg/cm ²	B
cm H2O	C
mbar	G
Bar	H
KPa	J
m H2O	M
psi	P
mm H2O	T
Non standard requirement	X

Inner Scale

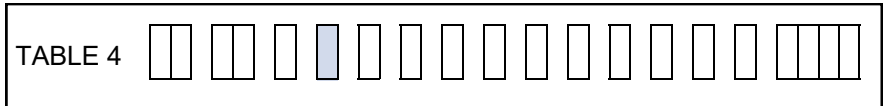

	Code
Inner scale not required	0
psi	P

Static Pressure

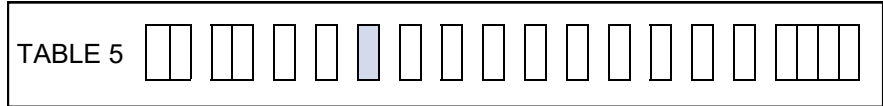

	Code
25 bar. For ranges up to 100 mbar	1
100 bar. For ranges up to 100 mbar	2
100 bar. For ranges over 100 mbar	3
250 bar. For ranges over 100 mbar	4
400 bar. For ranges over 100 mbar	5
600 bar. For ranges over 100 mbar	6
100 bar. For ranges up to 25 bar (for single diaphragm construction only)	7
100 Bar. For ranges up to 400 mbar (for single diaphragm construction only)	8

Gauge Diameter

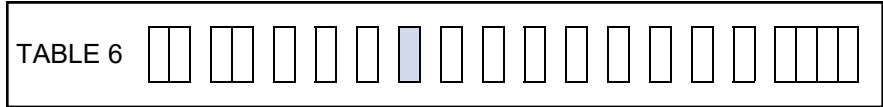

	Code
100mm (nominal 4")	4
150mm (nominal 6")	6

Mounting

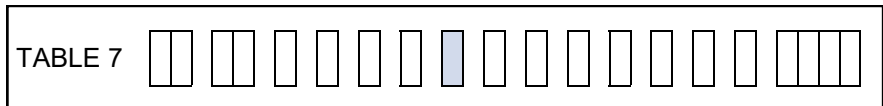

	Code
Bottom Connection, Direct	A
Bottom Connection, Surface, Case Mounting Plate	B
Bottom Connection, Flush, Cover Mounting Plate	F
Bottom Connection, for 2inch horizontal or vertical pipe, Mounting	J

Fill

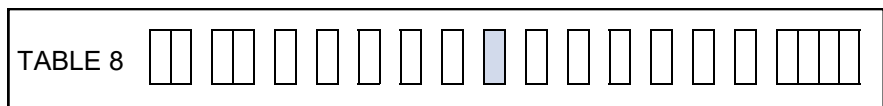

	Code
No Fill	0
Fillable	E
Glycerin	G
Silicone	S

Optional: Fluoride fluid is available for case filling for oxygen service applications (Table - 15, code 4 or 5)

Diaphragm Differential Pressure
Models: DG range

Accuracy Class

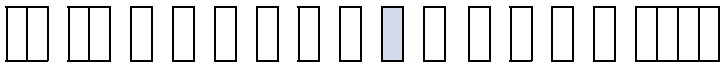
TABLE 9 

	Code
Class 1.0 (+/-1 percent of full scale deflection) for dry execution only (raising pressure)	A
Class 1.6 (+/-1.6 percent of full scale deflection)	B

Process Connection

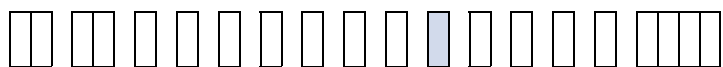
TABLE 10 

	Code
1/4 – 18NPT Internal (All materials)	F
1/2-14 NPT Internal (316 Stainless Steel)	H
1/2-14 NPT External (316 Stainless Steel)	J
G1/2B (316 Stainless Steel)	K
G1/2 (1/2inch BSPP of 316 stainless steel)	L
1/4-18NPT External (All materials)	P
1/2 - 14NPT External (Hastelloy) for double diaphragm	1
G1/2B (Hastelloy) for double diaphragm	2
1/2 - 14NPT External (Monel) for double diaphragm	3
G1/2B (Monel) for double diaphragm	4
G1/2 (1/2inch BSPP of Hastelloy) for double diaphragm	5
G1/2 (1/2inch BSPP of Monel) for double diaphragm	6
Fitted with chemical seal which affects the accuracy of the instruments	9

Material of Wetted Parts

TABLE 11 

	Code
Hastelloy C276 for double diaphragm only (for ranges exceeding 100mbar)	1
Hastelloy C276 for double diaphragm only (for ranges not exceeding 100mbar)	2
Monel for double diaphragm only (for ranges exceeding 100mbar)	3
Monel for double diaphragm only (for ranges not exceeding 100mbar)	4
All Hastelloy C276 for double diaphragm only (for ranges exceeding 100mbar)	H
All Hastelloy C276 for double diaphragm only (for ranges not exceeding 100mbar)	J
All Monel for double diaphragm only (for ranges exceeding 100mbar)	M
All Monel for double diaphragm only (for ranges not exceeding 100mbar)	N
Connections 316L and AISI 316Ti 1.4571	S

Material of Gauge Case

TABLE 12 

	Code
Case and ring in AISI 304 stainless steel	0
Gauge nominal diameter 100mm (4inch), case and ring with bayonet bezel in AISI 316 stainless steel	1
Gauge nominal diameter 150mm (6inch), case and ring with bayonet bezel in AISI 316 stainless steel	2
Gauge nominal diameter 100mm (4inch), case and ring in AISI 304 stainless steel and window of laminated safety glass.	A
Gauge nominal diameter 150mm (6inch), with case and in AISI 304 stainless steel and window of laminated safety glass	B
Gauge nominal diameter 100mm (4inch), with case and in AISI 316 stainless steel and window of laminated safety glass	C
Gauge nominal diameter 150mm (6inch), with case and in AISI 316 stainless steel and window of laminated safety glass	D

Scale Pointer Options

TABLE 13 

	Code
Standard only no options this model	0
Maximum pointer to indicate maximum pressure reached for nominal gauge diameter 100mm (4inch)	1
Maximum pointer to indicate maximum pressure reached for nominal gauge diameter 150mm (6inch)	2

Options Available

TABLE 14 

	Code
No additional options required	0
Tag number printed on dial face	1
Stainless steel tag plate	4
Serial number printed on dial face	5
Stainless steel tag plate and Red mark on dial	9
Writings on dial	A
Non standard requirement	X

Treatments Available

TABLE 15 

	Code
No additional treatment required	0
Tropicalised	1
Wetted parts prepared for Oxygen service. For ranges above 100 mBar	4
Wetted parts prepared for Oxygen service. For ranges up to and including 100 mBar	5

Diaphragm Differential Pressure
Models: DG range

Special Requirements

TABLE 16																	
	Code																
Special requirements	XXX																

**Type of Mounting
Table 7**

Code A

Bottom Connection, Direct
(Double diaphragm)

Code A

Bottom Connection, Direct
(Single diaphragm)

MODELS DG/DA		DN	A	B	C	D	E	F	G	H	I	L	M	N	Hole Ø at 120°	Weight		
																No-fill	Filled	
Ranges from 100 mbar to 25 bar	DOUBLE DIAPHRAGM	100	103	150	112	100	22	1/4	118			54					4,8	5,1
		150	150	150	112	100	22	1/4	166			54					5,0	5,7
Ranges from 25 mbar to 100 mbar	DOUBLE DIAPHRAGM	100	103	200	137	150	22	1/4	118			54					10,7	11,0
		150	150	200	137	150	22	1/4	166			54					10,9	11,6
All ranges	SINGLE DIAPHRAGM	100	103	142	120	95	22	1/4	118	7		54	126	140	27	5	2,1	2,5
		150	150	142	120	95	22	1/4	166	7		54	178	192	27	5	2,3	3,1

Code B

Bottom Connection, Surface, Case Mounting Plate
(Double diaphragm)

Code B

Bottom Connection, Surface, Case Mounting Plate
(Single diaphragm)

MODELS DG/DA		DN	A	B	C	D	E	F	G	H	I	L	M	N	Hole Ø at 120°	Weight		
																No-fill	Filled	
Ranges from 100 mbar to 25 bar	DOUBLE DIAPHRAGM	100	103	150	112	100	22	1/4	118			54					5,1	5,4
		150	150	150	112	100	22	1/4	166			54					5,3	6,0
Ranges from 25 mbar to 100 mbar	DOUBLE DIAPHRAGM	100	103	200	137	150	22	1/4	118			54					11,0	11,3
		150	150	200	137	150	22	1/4	166			54					11,2	11,9
All ranges	SINGLE DIAPHRAGM	100	103	142	120	95	22	1/4	118	7		54	126	140	27	5	2,1	2,5
		150	150	142	120	95	22	1/4	166	7		54	178	192	27	5	2,3	3,1

Diaphragm Differential Pressure
Models: DG range

Type of Mounting
Table 7

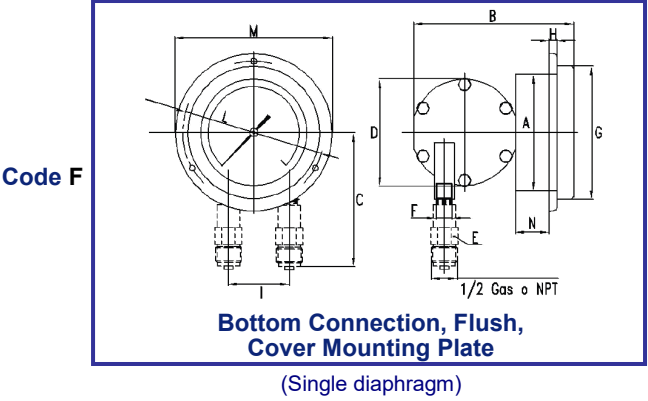
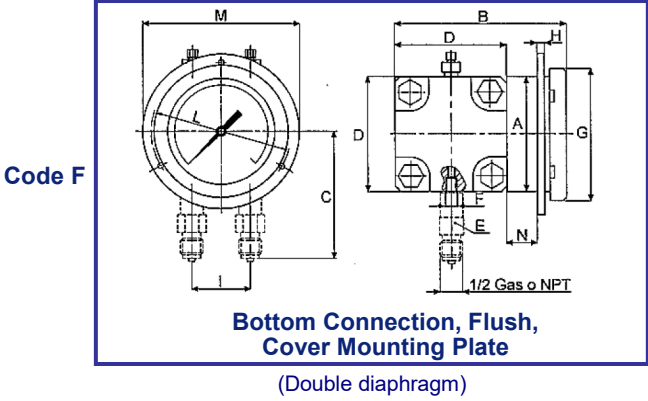

MODELS DG/DA		DN	A	B	C	D	E	F	G	H	I	L	M	N	Hole Ø at 120°	Weight	
																No-fill	Filled
Ranges from 100 mbar to 25 bar	DOUBLE DIAPHRAGM	100	103	150	112	100	22	1/4	118	7	54	126	140	27	5	4,9	5,2
		150	150	150	112	100	22	1/4	166	7	54	178	192	27	5	5,1	5,8
Ranges from 25 mbar to 100 mbar	DOUBLE DIAPHRAGM	100	103	200	137	150	22	1/4	118	7	54	126	140	27	5	10,8	11,1
		150	150	200	137	150	22	1/4	166	7	54	178	192	27	5	11,0	11,7
All ranges	SINGLE DIAPHRAGM	100	103	142	120	95	22	1/4	118	7	54	126	140	27	5	2,1	2,5
		150	150	142	120	95	22	1/4	166	7	54	178	192	27	5	2,3	3,1

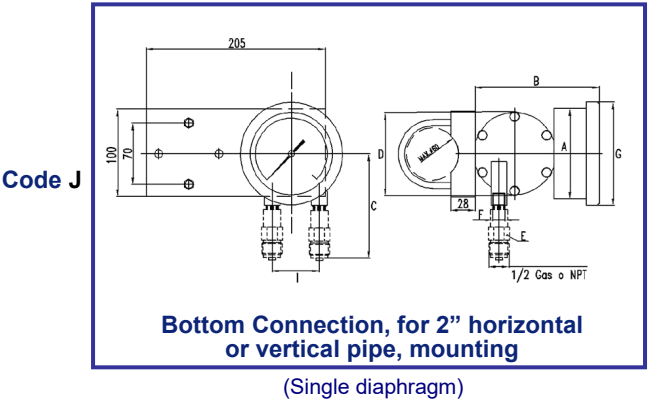
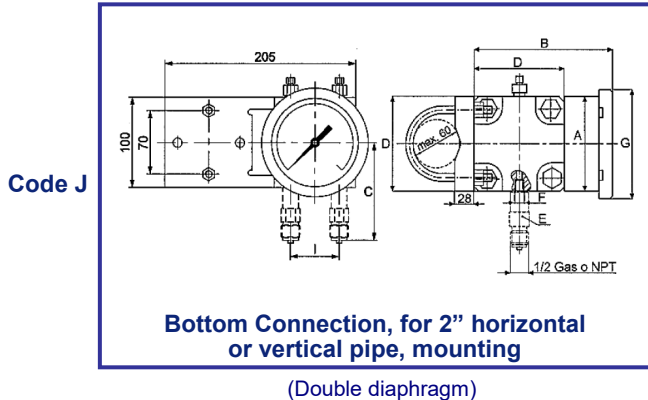

MODELS DG/DA		DN	A	B	C	D	E	F	G	H	I	L	M	N	Hole Ø at 120°	Weight	
																No-fill	Filled
Ranges from 100 mbar to 25 bar	DOUBLE DIAPHRAGM	100	103	150	112	100	22	1/4	118		54					5,4	5,7
		150	150	150	112	100	22	1/4	166		54					5,6	6,3
Ranges from 25 mbar to 100 mbar	DOUBLE DIAPHRAGM	100	103	200	137	150	22	1/4	118		54					11,3	11,6
		150	150	200	137	150	22	1/4	166		54					11,5	12,2
All ranges	SINGLE DIAPHRAGM	100	103	142	120	95	22	1/4	118	7	54	126	140	27	5	2,1	2,5
		150	150	142	120	95	22	1/4	166	7	54	178	192	27	5	2,3	3,1

In the interest of development and improvement Delta Mobrey Ltd, reserves the right to amend, without notice, details contained in this publication. No legal liability will be accepted by Delta Mobrey Ltd for any errors, omissions or amendments.

Delta Mobrey Limited
Hudson House, Albany Park, Camberley, Surrey, UK GU16 7PL
T+44 (0)1252 729140 F+44 (0)1252 729168 E sales@delta-mobrey.com W www.delta-mobrey.com

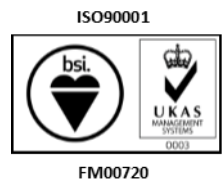

FM00720

Diaphragm Differential Pressure
Models: DG range

Approvals

EUROPEAN DIRECTIVE



Pressure Equipment Directive (PED) 2014/68/EU

Compliant to PED, Module A for static Pressure > 200 Bar, SEP for Static Pressure ≤200bar

ATEX Directive 2014/34/EU



CONSTRUCTION SAFETY— Technical file storage reference SGS21ATEX0095DR

Notified body for Technical storage file : SGS Fimko Oy, Helsinki, Finland, Notified Body No 0598

- Ex h IIC T6 Gb X
- Ex h IIIC T85°C Db X

UK REGULATION



Pressure Equipment (Safety) Regulation 2016

S.I. 2016 no. 1105, as amended, Module A for static Pressure > 200 Bar, SEP for Static Pressure ≤200bar

Equipment and Protective Systems Intended for use in Potentially

Explosive Atmospheres Regulation 2016



(S.I. 2016 No. 1107 as amended)

CONSTRUCTION SAFETY— Technical file storage reference BAS21UKEx0356TDR

Approved body for Technical storage file : SGS Baseefa Ltd, Buxton, United Kingdom, Approval Body No 1180

- Ex h IIC T6 Gb X
- Ex h IIIC T85°C Db X

In the interest of development and improvement Delta Mobrey Ltd, reserves the right to amend, without notice, details contained in this publication. No legal liability will be accepted by Delta Mobrey Ltd for any errors, omissions or amendments.

Delta Mobrey Limited

Hudson House, Albany Park, Camberley, Surrey GU16 7PL, UK.

T+44 (0)1252 729140 F+44 (0)1252 729168 E sales@delta-mobrey.com W www.delta-mobrey.com

ISO90001



FM00720